

连接件

挤压角铝 80×80×12-90°

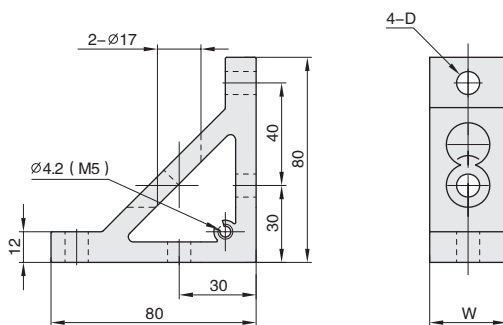

















■ 产品特点：从挤压型材上截取料段经钻孔加工而成，连接强度高，灵活性和通用性好，安装简单方便，主要用于型材的 T 型、L 型、十字连接。



材质	铝合金
表面处理	阳极氧化

订购编号	适用型材	规格	D	W	加工代码	单品重量 (g)	紧固组件
CCE-80-12-4040	 40 系列 40mm	单个供货	9	30	-	146	-
CCE-80-12-4040-ST		成套供货			-		C14x2+C15x2
CCE-80-12-4040-M5		加工供货			M5		-
CCE-80-12-4040-M5-ST		成套加工供货			M5		C14x2+C15x2+C08x1
CCE-80-12-4545	 45 系列 45mm	单个供货	9	35	-	173.5	-
CCE-80-12-4545-ST		成套供货			-		C16x2+C17x2
CCE-80-12-4545-M5		加工供货			M5		-
CCE-80-12-4545-M5-ST		成套加工供货			M5		C16x2+C17x2+C08x1
CCE-80-12-5050	 50 系列 50mm	单个供货	9	40	-	200	-
CCE-80-12-5050-ST		成套供货			-		C16x2+C17x2
CCE-80-12-5050-M5		加工供货			M5		-
CCE-80-12-5050-M5-ST		成套加工供货			M5		C16x2+C17x2+C08x1

■ 紧固组件

C08	C14	C15	C16	C17
 内六角平圆头螺钉 PSHF-M5-10-D	 内六角圆柱头螺钉 PSHC-M8-25-D	 内六角圆柱头螺钉 PSHC-M8-20-D	 内六角圆柱头螺钉 PSHC-M8-25-D	 内六角圆柱头螺钉 PSHC-M8-20-D
-	 后装弹珠螺母 BEE-40-M8	 后装弹珠螺母 BEE-40-M8	 T型螺母 BCE-45-M8	 T型螺母 BCE-45-M8
 平垫圈 PWFN-5-D	 平垫圈 PWFN-8-D	-	 平垫圈 PWFN-8-D	-
-	 弹簧垫圈 PWS-8-D	 弹簧垫圈 PWS-8-D	 弹簧垫圈 PWS-8-D	 弹簧垫圈 PWS-8-D

连接件

挤压角铝 80×80×12-90°



技术信息

1 铝型材

2 紧固件

3 连接件

4 型材附件

5 地面组件

6 防护系列

7 门窗组件

8 精益管及配件

■ 产品特点：从挤压型材上截取料段经钻孔加工而成，连接强度高，灵活性和通用性好，安装简单方便，主要用于型材 45 度角的连接。



材质	铝合金
表面处理	阳极氧化

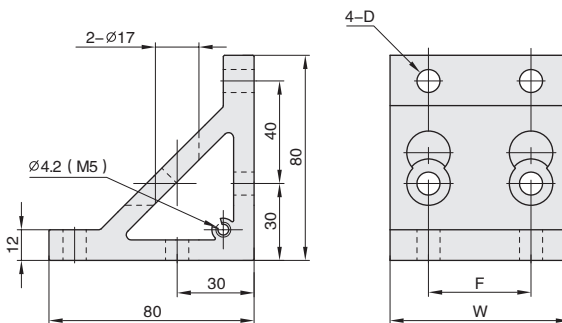

订购编号	适用型材	规格	D	W	F	加工代码	单品重量 (g)	紧固组件
CCE-80-12-4080	40 系列 80mm	单个供货	9	70	40	-	345.6	-
CCE-80-12-4080-ST		成套供货				-		C14 x4+ C15 x4
CCE-80-12-4080-M5		加工供货				M5		-
CCE-80-12-4080-M5-ST		成套加工供货				M5		C14 x4+ C15 x4+ C08 x1
CCE-80-12-4590	45 系列 90mm	单个供货	9	80	45	-	400	-
CCE-80-12-4590-ST		成套供货				-		C16 x4+ C17 x4
CCE-80-12-4590-M5		加工供货				M5		-
CCE-80-12-4590-M5-ST		成套加工供货				M5		C16 x4+ C17 x4+ C08 x1
CCE-80-12-50100	50 系列 100mm	单个供货	9	90	50	-	453	-
CCE-80-12-50100-ST		成套供货				-		C16 x4+ C17 x4
CCE-80-12-50100-M5		加工供货				M5		-
CCE-80-12-50100-M5-ST		成套加工供货				M5		C16 x4+ C17 x4+ C08 x1

■ 紧固组件

C08	C14	C15	C16	C17
内六角平圆头螺钉 PSHF-M5-10-D	内六角圆柱头螺钉 PSHC-M8-25-D	内六角圆柱头螺钉 PSHC-M8-20-D	内六角圆柱头螺钉 PSHC-M8-25-D	内六角圆柱头螺钉 PSHC-M8-20-D
-	后装弹珠螺母 BEE-40-M8	后装弹珠螺母 BEE-40-M8	T型螺母 BCE-45-M8	T型螺母 BCE-45-M8
平垫圈 PWFN-5-D	平垫圈 PWFN-8-D	-	平垫圈 PWFN-8-D	-
-	弹簧垫圈 PWS-8-D	弹簧垫圈 PWS-8-D	弹簧垫圈 PWS-8-D	弹簧垫圈 PWS-8-D

连接件

挤压角铝 80×80×12-90°



■ 产品特点：从挤压型材上截取料段经钻孔加工而成，连接强度高，灵活性和通用性好，安装简单方便，主要用于型材 45 度角的连接。





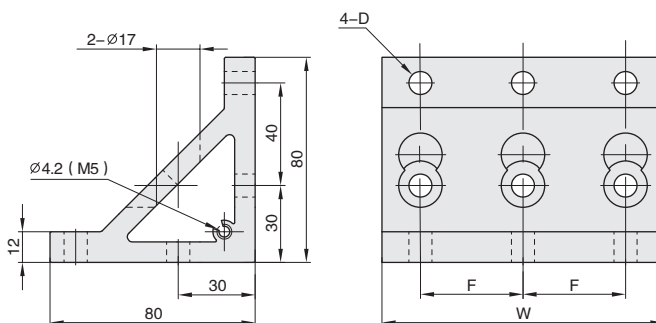





材质	铝合金
表面处理	阳极氧化



订购编号	适用型材	规格	D	W	F	加工代码	单品重量 (g)	紧固组件
CCE-80-12-40120	 40 系列 120mm	单个供货	9	110	40	-	546	-
CCE-80-12-40120-ST		成套供货				-		C14x6+C15x6
CCE-80-12-40120-M5		加工供货				M5		-
CCE-80-12-40120-M5-ST		成套加工供货				M5		C14x6+C15x6+C08x1

■ 紧固组件

C08	C14	C15
 内六角平圆头螺钉 PSHF-M5-10-D	 内六角圆柱头螺钉 PSHC-M8-25-D	 内六角圆柱头螺钉 PSHC-M8-20-D
-	 后装弹珠螺母 BEE-40-M8	 后装弹珠螺母 BEE-40-M8
 平垫圈 PWFN-5-D	 平垫圈 PWFN-8-D	-
-	 弹簧垫圈 PWS-8-D	 弹簧垫圈 PWS-8-D

连接件

挤压角铝 80×80×12-90°



技术信息

■ 产品特点：从挤压型材上截取料段经钻孔加工而成，连接强度高，灵活性和通用性好，安装简单方便，主要用于型材 45 度角的连接。

1 铝型材



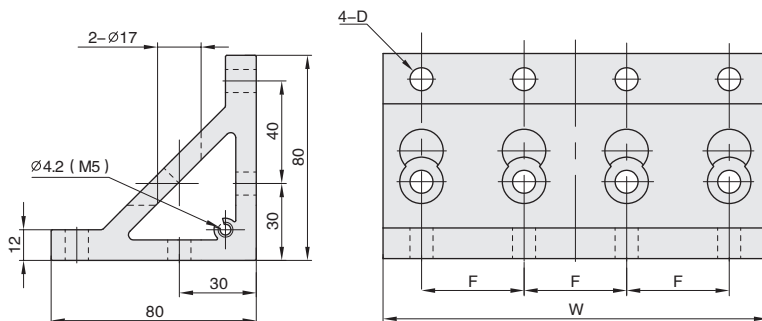

2 紧固件

材质	铝合金
表面处理	阳极氧化



3 连接件

订购编号	适用型材	规格	D	W	F	加工代码	单品重量 (g)	紧固组件
CCE-80-12-40160	 40 系列 160mm	单个供货	9	150	40	-	746.5	-
CCE-80-12-40160-ST		成套供货				-		C14x8+C15x8
CCE-80-12-40160-M5		加工供货				M5		-
CCE-80-12-40160-M5-ST		成套加工供货				M5		C14x8+C15x8+C08x1
CCE-80-12-45180	 45 系列 180mm	单个供货	9	170	45	-	854.5	-
CCE-80-12-45180-ST		成套供货				-		C16x8+C17x8
CCE-80-12-45180-M5		加工供货				M5		-
CCE-80-12-45180-M5-ST		成套加工供货				M5		C16x8+C17x8+C08x1

6 防护系列

■ 紧固组件

C08	C14	C15	C16	C17
内六角平圆头螺钉 PSHF-M5-10-D	内六角圆柱头螺钉 PSHC-M8-25-D	内六角圆柱头螺钉 PSHC-M8-20-D	内六角圆柱头螺钉 PSHC-M8-25-D	内六角圆柱头螺钉 PSHC-M8-20-D
-	后装弹珠螺母 BEE-40-M8	后装弹珠螺母 BEE-40-M8	T型螺母 BCE-45-M8	T型螺母 BCE-45-M8
平垫圈 PWFN-5-D	平垫圈 PWFN-8-D	-	平垫圈 PWFN-8-D	-
-	弹簧垫圈 PWS-8-D	弹簧垫圈 PWS-8-D	弹簧垫圈 PWS-8-D	弹簧垫圈 PWS-8-D

7 门窗组件

8 精益管及附件