

把手锁

无锁芯型 · 有锁芯型



大批量
订购
bulk order

■ 无锁芯型 · 有锁芯型



代号	材质			表面处理			参考重量 (kg)		
	基座	把手	锁舌	基座	把手	锁舌			
LKBZGC	ZDC5		S45C	镀亮铬		镀锌	0.245		
LKBZFD							0.251		
LKBZGW							0.262		
LKBZGJ						喷无光黑			0.2
LKBZGQ						镀亮铬		镀蓝白锌	
LKBZGD			喷麻面黑						
LKBSGE	SUS316		SUS316	-	-	-	0.38		
LKBZFE	ZDC5		S45C	镀亮铬		镀蓝白锌	0.2		
LKBZFB				喷麻面黑					
LKBZFC	SUS316		SUS316	-	-	-	0.38		

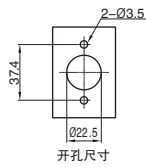
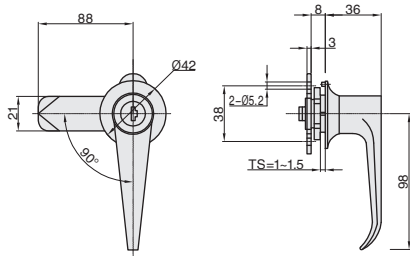

LKBZGC
LKBZFD

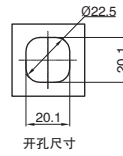
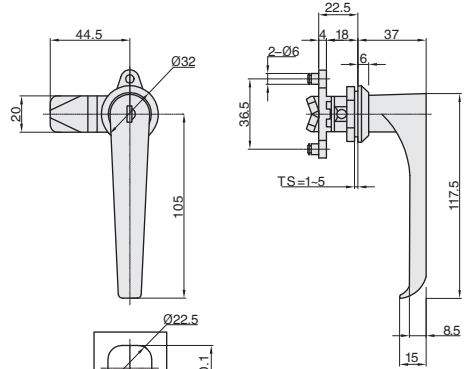

LKBZGW
LKBZGJ

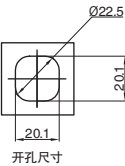
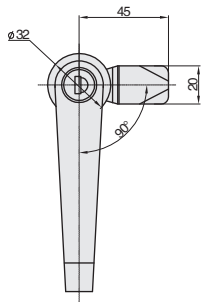

LKBZGQ
LKBZGD
LKBZGD
LKBZFE
LKBZFB
LKBZFC

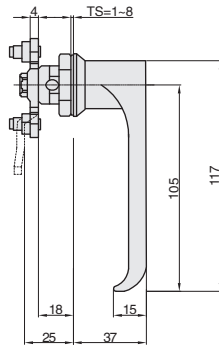

订购编号示例

① 代号
LKBZGC
LKBZFD
LKBZGW



小单	中大单	大单
1-50	51-100	101~
通常	7 工作日	咨询客服



1-9	10~
100%	另行报价