

垂直式快速夹钳

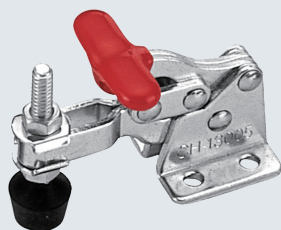

★ 产品特点：主体材质Q235，压把开启角度为80°，手柄开启角度为88°

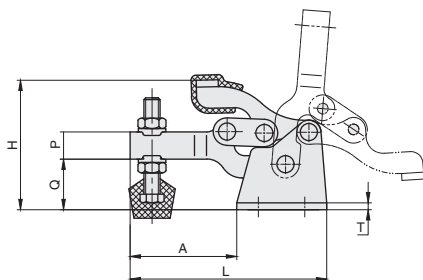

QC-13005
底座尺寸

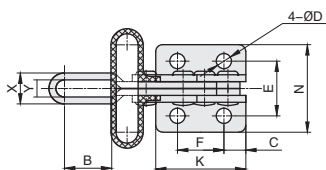

QC-13007、QC-13008
底座尺寸

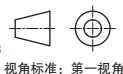

视角标准：第一视角



① 代号
QC1-13005

① 代号	夹持力	压头型号	自重	A	B	C	D	E
QC1-13005	68kg	QC-FC-10138	60g	30.8	12.7	6.4	4.4	15.9
QC1-13007	150kg	QC-FC-56212	230g	15.4	19.5	10.3	7	29.4
QC1-13008	320kg	QC-FC-38312	590g	18.4	28.9	12.7	7.9	38.1
QC1-13005-SS	尺寸与QC1-13005相同，主体材质为不锈钢							
QC1-13007-SS	尺寸与QC1-13007相同，主体材质为不锈钢							

① 代号	F	F ₁	F ₂	H	K	L	N	Q	P	T	X	Y
QC1-13005	13.5	-	-	35.2	26.2	57	25.4	14.7	7.9	2	9	5
QC1-13007	-	19	27	58.7	44	93.7	46	22.2	12.7	3	15.4	9.4
QC1-13008	-	31	39	88.1	64.3	135	62.7	33.3	19	3	18.4	10.4
QC1-13005-SS	尺寸与QC1-13005相同，主体材质为不锈钢											
QC1-13007-SS	尺寸与QC1-13007相同，主体材质为不锈钢											

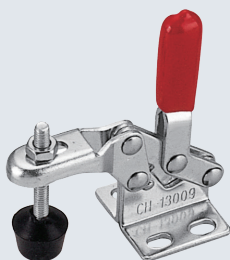

★ 产品特点：主体材质Q235，压把开启角度为80°，手柄开启角度为88°

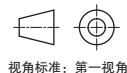
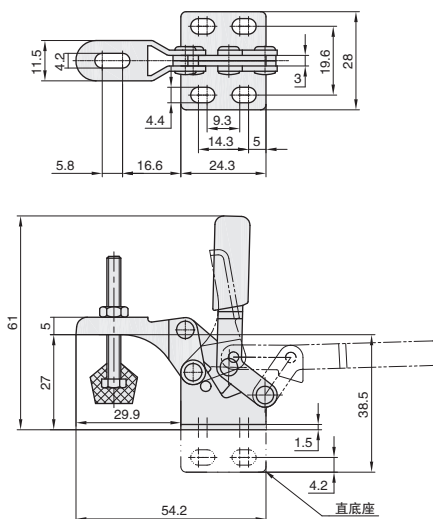

视角标准：第一视角



① 代号
QC1-13009

① 代号	压把样式	底座样式	把手样式	夹持力	压头型号	自重
QC1-13009	滑道	平面法兰底座	直把手	30kg	QC-FC-044207	40g
QC1-14009	滑道	直底座	直把手			