

# YN115CEI8RPIO IO-Link master

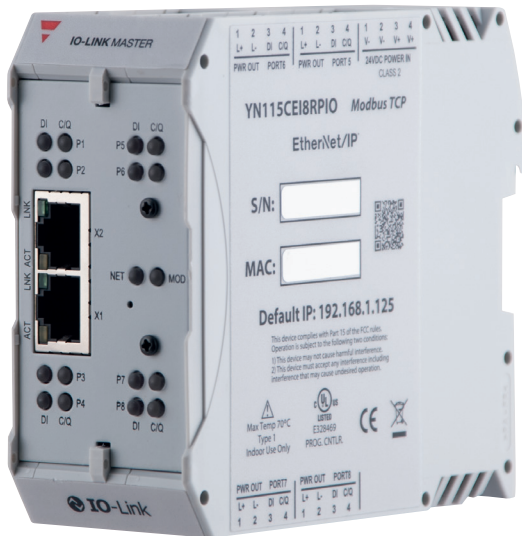

## DIN rail IO-Link master with EtherNet/IP™, Modbus/TCP, OPC UA



### Benefits

- Eight port IO-Link Master to EtherNet/IP™ which allows up to eight sensor or actuator connections on a single master
- Additional digital input on every port
- Pluggable/removable push-in and screw terminal connectors for IO-Link and Power
- IP20 DIN rail mount enclosure
- EtherNet/IP™ and Modbus/TCP access to IO-Link process, event and service data
- OPC UA support
- Integrated web server and IODD interpreter
- Dual Ethernet ports via RJ45
- Multi-colour LEDs for device, network, and port status diagnostics
- Wide operating temperature range (-40° to +70°C)
- IO-Link V1.0 and V1.1 compatibility
- IO-Link COM1, COM2 and COM3 (230K baud rate)

### Description

Y series of IO-Link masters fully satisfy the most demanding industrial communication needs. YN115CEI8RPIO is DIN rail mount fieldbus module with eight IO-Link ports, compatible with IO-Link V1.0 and V1.1. It is a gateway solution with support for EtherNet/IP™ fieldbus system. Thanks to a powerful web interface and integrated IODD interpreter it is possible to configure and diagnose the IO-Link master even from a tablet or smartphone and easily read, parameterize or configure the IO-Link devices connected. Thanks to IO-Link V 1.1 it is possible to replace a connected device by downloading all parameters into a replacement device automatically from the Master. With Y series IO-Link masters it is possible to simultaneously provide data access via different communication protocols like EtherNet/IP™, Modbus/TCP and OPC UA to multiple controllers.

### Main features

- Embedded web server and IODD interpreter to configure and access diagnostic information of the attached IO-Link devices and of the fieldbus module itself (e.g. setting the IP address and subnet mask) without the need of a specific software
- Possibility to store the configuration of all devices connected in the IO-Link master memory to allow the system to work even without a higher-level PLC and to enable error-proof sensor replacement with automatic parameterization
- IIoT ready, thanks to the integrated OPC UA interface that allows reliable, continuous and transparent data transfer between the field level (sensor/actuator) and higher-level cloud systems in full compliance with the Industry 4.0 requirements
- Quick and easy installation on a standard DIN rail
- Pluggable/removable connectors, supplied together with the IO-Link Master, allow high flexibility and time saving in any installation
- Industrial grade components and redundant power inputs make Y series IO-Link masters exceptionally reliable for critical applications
- Multi-colour LEDs with status and diagnostics information for each channel

### Main functions

IO-Link masters allow to connect all sections of a plant in a single industrial network, from the management level (ERP) right down to the field level (sensors and actuators) to increase the availability and efficiency of machines and plants. In addition to this, Y series IO-Link masters are specifically designed to enable the complete integration into the industrial communication system.

## References

**Order code**

**YN115CEI8RPIO**

## Structure

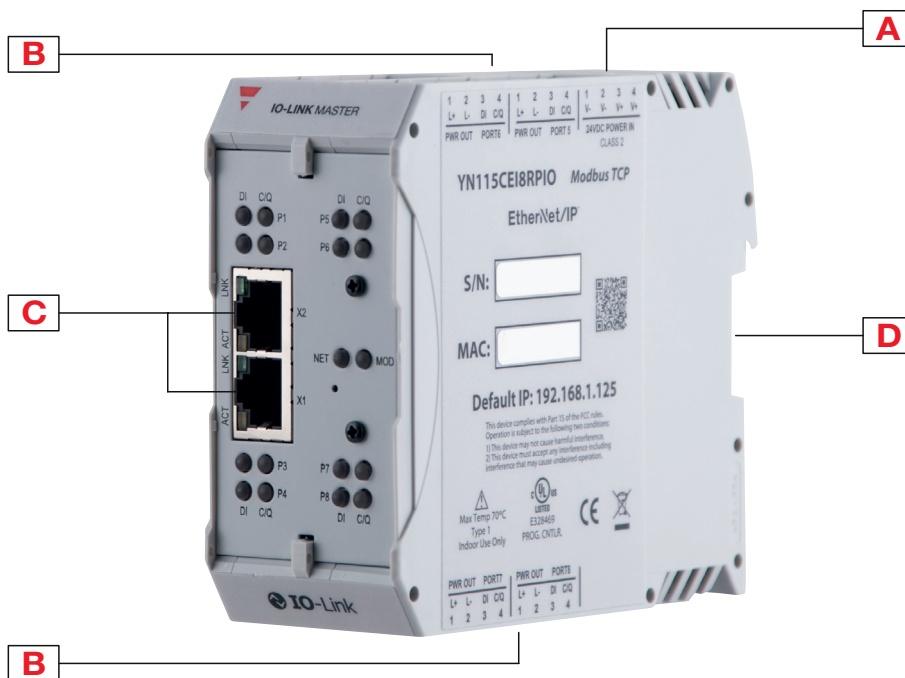

Element	Function
A	Power input port
B	IO-Link ports
C	Ethernet ports, RJ45
D	DIN rail

## Dimensions

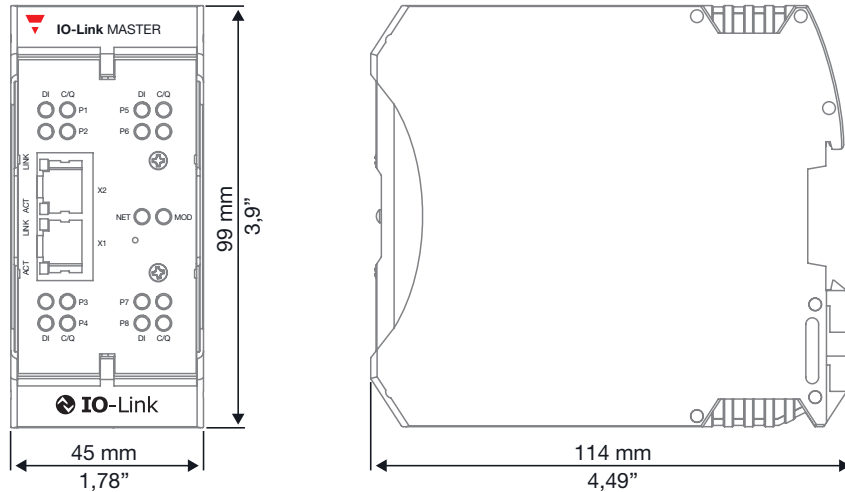

## Features

### General

<b>Configuration</b>	Embedded web interface, IO-Link, EtherNet/IP and Modbus TCP
<b>Data Storage</b>	Automatic or Manual - Upload and/or Download
<b>Device Validation</b>	Yes
<b>Data Validation</b>	Yes
<b>Diagnostics</b>	IO-Link, EtherNet/IP™ and Modbus TCP
<b>Powerful Web Interface</b>	Provides: firmware upgradable; password protected with admin, operator, and user accounts; ISDU batch handling; load IODD files to configure the IO-Link Device; IODD Handler parses xml files making them readable and configurable; Log files; Save/Load configuration files
<b>Upgradable Firmware</b>	Yes (via web GUI)
<b>Remote Parameterization</b>	Yes

### Power Supply

<b>Rated operating voltage <math>U_o</math></b>	18 - 30 VDC
<b>Nominal current</b>	3.7 A max. @ 24 VDC
<b>Current consumption (system electronics)</b>	155 mA @ 24 VDC
<b>Power consumption (system electronics)</b>	3.75 W







**Mechanical data**

<b>Housing material</b>	Polyamide
<b>Channels</b>	8 x IO-Link / Digital I/O (configurable)
	8 x Digital Input DI
	2 x Ethernet
<b>Weight</b>	272 g
<b>Installation</b>	DIN rail mounting

**Environmental**

<b>Protection degree</b>	IP20
<b>Ambient temperature</b>	Operating: -40°C to +70°C
	Storage: -40°C to +85°C
<b>Ambient humidity (non condensing)</b>	Operating: 10% to 95%
	Storage: 10% to 95%
<b>Shock / Vibrations</b>	EN60068-2-6; EN60068-2-27
<b>Altitude</b>	0 - 2000m

**Compatibility and conformity**

<b>Immunity</b> European standard EN 61000-6-2	EN/IEC 61131-2 and EN/IEC 61131-9: IEC 61000-4-2: Electrostatic Discharge IEC 61000-4-3: Radiated, Radio-Frequency IEC 61000-4-4: Fast transient/Burst IEC 61000-4-5: Surge IEC 61000-4-6: Conducted disturbance IEC 61000-4-8: Magnetic field IEC 61000-4-11: Dips and voltage variations
<b>Emissions</b>	European Standard EN 61000-6-4
	International Standard IEC 61000-6-4
	AS/NZS CISPR-11
	FCC Part15 Subpart B; Class A limit
	Canadian EMC requirements ICES-001
<b>Safety</b>	CSA C22.2 No. 61010-1-12 / CSA C 22.2 No. 61010-1-201
	UL 61010-1 / UL 61010-1-201
<b>Vibration</b>	IEC 60068-2-6
<b>Mechanical Shock</b>	IEC 60068-2-27
<b>Environmental / Mechanical Test Approvals</b>	IEC 61131-2; IEC 60529
<b>Approvals</b>	   <b>IO-Link</b> 
<b>Other</b>	The components of this product comply with the requirements of the EMC/EMI directive 2014/30/EU, directive 2011/65/EU on the restriction of the use of certain hazardous substances (RoHS2)

## Connectors

### Power

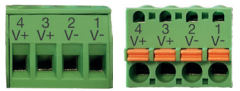
<b>Power connector</b>	1	
<b>Connector type</b>	Pluggable screw terminal or push-in spring screwless terminal	
<b>Pin-Out</b>	Pin 1: V- Pin 2: V- Pin 3: V+ Pin 4: V+	

### IO-Link ports

<b>Channels</b>	8 x IO-Link / Digital I/O (configurable) 8 x DI	
<b>Connector type</b>	Pluggable screw terminal or push-in spring screwless terminal	
<b>IO-Link version</b>	Supports V1.0 and V1.1	
<b>Pin-Out</b>	Pin 1: L+ Pin 2: L- Pin 3: DI Pin 4: C/Q (configurable)	
<b>Configurations per port</b>	Pin 2: DI Pin 4 (configurable): IO-Link, DI (SIO mode), DO (SIO mode)	
<b>Output Current L+/L-</b>	200 mA	
<b>Output Current C/Q (Pin 4)</b>	200 mA	
<b>Output Current per Master (C/Q &amp; L+/L-)</b>	3.2 A (max.)	
<b>IO-Link Mode Transfer Rates</b>	4.8K (COM1); 38.4K (COM2); 230.4K (COM3)	
<b>Baud Rate Recognition</b>	Automatic	
<b>Cable Length (max.)</b>	20 m	
<b>Protection</b>	Short circuit protection	

<b>Digital input SIO mode (PIN 4)</b>	
<b>Input characteristics</b>	IEC 61131-2 Type 1 and Type 3 compliant
<b>Input threshold</b>	High: 10.5 – 13.0V Low: 8.0 – 11.5V
<b>Sensor supply current (L+/L-)</b>	200mA
<b>Sensor supply current per master</b>	1.6A (max.)
<b>Cable length (max.)</b>	30m

<b>Digital output SIO mode (PIN 4)</b>	
<b>Typical Output Voltage</b>	24 VDC
<b>Output Current (max.)</b>	200 mA
<b>Output Current per Master</b>	1.6 A (max.)
<b>Protection</b>	Overload and short circuit protection
<b>Output Function</b>	PNP/NPN (Push-Pull)
<b>Cable length (max.)</b>	30 m



Digital input (PIN 3, dedicated)	
Input characteristics	IEC 61131-2 Type 1 and Type 3 compliant
Input threshold	High: 6.8 – 8.0V Low: 5.2 – 6.4V
Typical input current	3 mA
Reverse polarity protected	Yes (-40V to +40V)
Cable length (max.)	30m

## Ethernet ports

Type	Industrial Ethernet
Number of ports	2
Connector type	RJ45
Ethernet Specification	10/100BASE-TX
Standards	IEEE 802.3: 10BASE-T IEEE 802.3u: 100BASE-TX
Auto-MDI/MDI-X	Yes
Auto-Negotiation	Yes
Link Distance	100 m
Cable Types	Unshielded/shielded twisted pair
IPv4 Addressing	Yes

## Protocols

### Ethernet/IP™ interface specifications

<b>Supported PLCs</b>	Including but not limited to: control logix, compact logix, RSLogix, SLC 500, PLC5, MicroLogix Other Class 1 or Class 3 EtherNet/IP PLCs may be supported
<b>ISDU read and writes</b>	Up to 40 individual commands in one EtherNet/IP message
<b>ISDU commands</b>	Selectable byte swapping (none, 16-bit, or 32-bit) Selectable payload sizes (4 to 232 bytes) ISDU block index ISDU sub-index Length of read or write Data payload
<b>Web page configuration</b>	Provides the following capabilities: port configuration for ISDU data, process data, transfer mode, read/write, write PDI to tag/file, and read PDO from tag/file. EtherNet/IP configuration: time to live (TTL) network value; multicast IP address allocation control; user-defined number of multicast IP addresses; user-defined multicast starting IP address; session encapsulation timeout
<b>Diagnostics</b>	Yes
<b>Electronic data sheets (EDS)</b>	Yes
<b>Sample PLC programs</b>	Yes

### Modbus TCP (slave)

<b>Supported controllers (modbus TCP masters)</b>	PLC, HMI, SCADA, OPC Server
<b>Supported clients</b>	Any modbus TCP client, applications on phones/tablets
<b>Web page configuration</b>	Port configuration for ISDU response timeout, process data, and transfer mode
<b>Diagnostics</b>	Yes

## LED indication

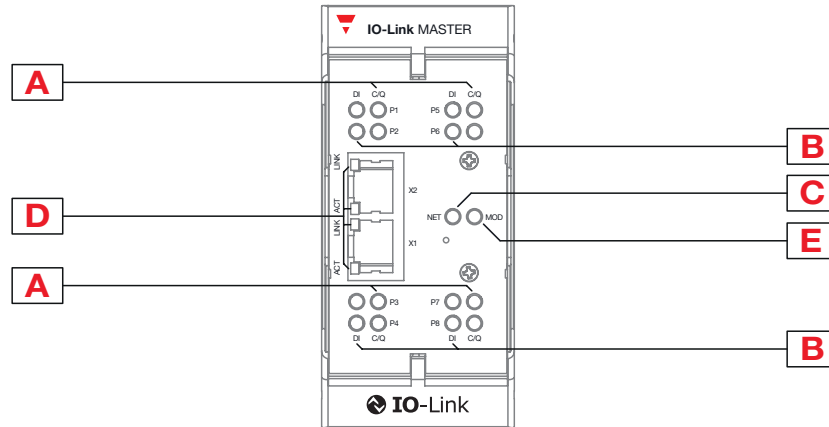

Element	Function
A	IO-Link status LEDs
B	DI status LEDs
C	Network status LED
D	Ethernet status LEDs
E	Module status LED

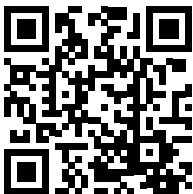

COPYRIGHT ©2020  
 Content subject to change. Download the PDF: [www.productselection.net](http://www.productselection.net)