

5.4

Exit signs - Indoor

Velos

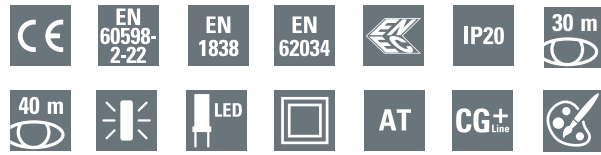

- Unit with innovative LED technology Certified family of emergency exit signs in accordance to EN 60598-2-22
- 3rd party certification
- Push button for test operation
- Ceiling, wall, suspension, recessed and lateral installation
- Models of 30m and 40m visibility
- Test functions

Light Source:

LED Strip with a lifetime of more than 60.000 hours
24 LEDs producing 140 lumens

Materials:

Base and reflector unit in white Polycarbonate
NiCd and NiMH batteries

Operation:

Maintained, slave and CBS models available
Autonomy from 1h up to 3h
Adjustable brightness function to 50% in mains operation
Functional test button
Telecommand, Inhibition operation
Autotest, CGLine+ and Slave models available

Installation:

Ceiling, wall, recessed, suspended through rope or metal pipe and lateral installation
No special tools required

Applications:

Schools, universities, public administration, commercial environments
Hotels, restaurants, meeting rooms, offices, shops, cinemas, theaters, museums
Areas with large heights and long viewing distance requirements

Velos is a range of emergency exit sign luminaires designed and equipped with technical solutions that make it suitable for a wide range of applications. The choice of exit sign labels makes the Velos range appropriated for emergency lighting requirements in multiple places such as offices, restaurants, hotels, hospitals and general commercial applications.

A complete range of accessories such as the recessed base for false ceiling installations, lateral and back base as well as suspension options allow for a variety of mounting positions. Velos is equipped with LED light source to provide an excellent uniform illumination of the legend comfortably meeting the requirements of EN1838.

The use of LEDs, automatic testing and monitoring devices (CGLine+) significantly reduce the operating and maintenance costs of the installation.

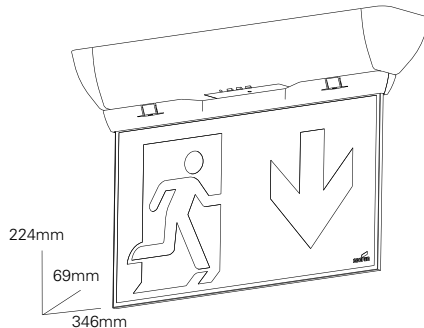

Viewing distance

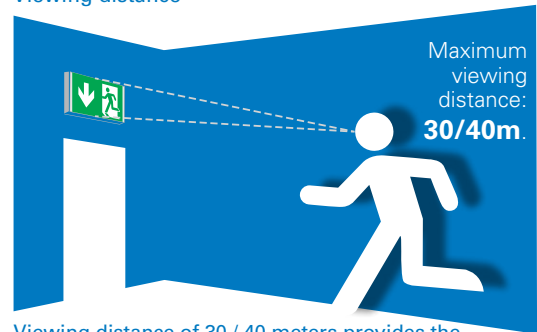

Viewing distance of 30 / 40 meters provides the ability to use fewer products and less power consumption per coverage area of an application.



Power Supply Unit

- 1 • Easy to install with no use of special tools required.
- Environmentally friendly: no heavy metals and energy-optimized charging process due to low self-discharge.
- 2 • Easy to connect power cables via screwless connectors for up to 2.5mm² cables.
- 3 • Multiple entrance points for power cables through base and main body of the power supply unit.
- Construction Material: Polycarbonate.
- Large capacity NiMH batteries with small construction size for compact luminaire design.

4 Velos electronics

- Fully automatic function test (weekly) or duration test (every 10 weeks).
- Testing button for manual triggering of function test.
- Autotest models available with simple fault analysis with two LED indication of battery / LED test and status display (operation, function test, duration test, failure).
- Easily set the level in mains operation to 50% or 100%.
- Increased product reliability with LED matrix orientation. By groups of 3, if one of the 24 LEDs fails, the intact LEDs will illuminate more brightly.



5 Velos Exit Sign

- Design life time: exceeding 60.000 hours lifetime expectancy using an EN1838 standard plate of 4mm thickness with 24 LED producing 140lm with minimum 240 cd/m² on white surface.
- 6 • Simple parts clicking with each other ensuring fast installation.

Velos viewing distance

- Velos provides a solution regarding viewing distance and emergency exit signs
- Viewing distance from 30 up to 40 meters, minimizing the number of lights into an installation, reducing the energy consumption of the emergency lighting in a building and installation and maintenance cost.
- Various accessories for ease of installation aiming to accommodate all possible applications and areas, with recessed base, wall mounting accessories, lateral direction base, suspended from ceiling either with rope or metal pipes.

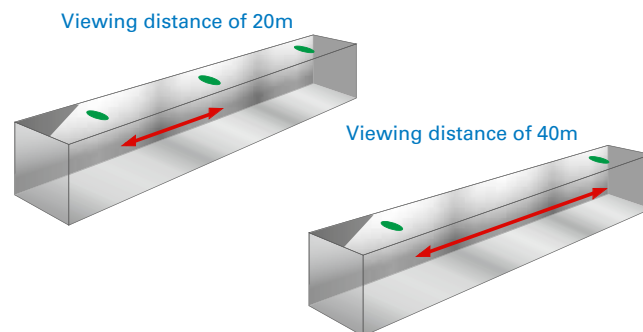

Velos optimal illumination

New exit sign plate used in Velos converts the high luminance of the LED into an illuminated surface with homogeneous brightness, with luminance of over 38 cd/m² on the white surface. As such the escape sign always remains easily recognisable even with poor visibility conditions or in bright surroundings.

Velos LEDs illuminate with a high efficiency of more than 112lm/W.

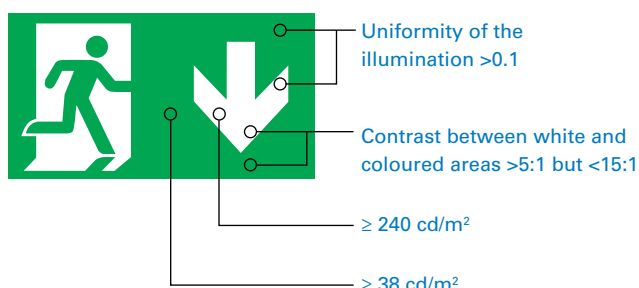

Photometric requirements for escape sign

EN 1838 (1999), Emergency lighting operation:

$L_{min} = 2 \text{ cd/m}^2$ (green surface) $L_{green} \geq 2 \text{ cd/m}^2$
 $L_{white} \geq 10 \text{ cd/m}^2$
 $5 \leq L_{white} / L_{green} \leq 15$

ISO 30061 (2007), When smoke is prime consideration:

$L_{green} \geq 10 \text{ cd/m}^2$
 $L_{white} \geq 50 \text{ cd/m}^2$

5.4



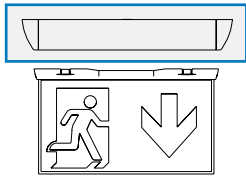

Exit signs - Indoor

Velos



PSU unit of Velos (order separately)

5

Order code	Description				
O-ESC	Velos PSU 1.5h	8.7VA/4.4W	1.5h	4AA Ni-Cd 800mA	Maintained
O-ESC-3H	Velos PSU 3h	8.7VA/4.4W	3h	4VTCs Ni-Cd 1700mA	Maintained
O-ESM-AT	Velos PSU 1h Auto Test	8.3VA/4.6W	1h	4AA NiMH 1100mA	Maintained
O-ESM-AT-3H	Velos PSU 3h Auto Test	8.8VA/4.9W	3h	4VTCs NiMH 2000mA	Maintained
O-ESC-CGL	Velos PSU CGL+, 1h	9.6VA/5.1W	1h	4AA Ni-Cd 800mA	Maintained
O-ESC-3H-CGL	Velos PSU, CGL+, 3h	9.6VA/5.1W	3h	4VTCs Ni-Cd 1700mA	Maintained

Ceiling mount

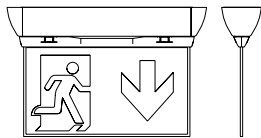

PSU + Exit Sign → Velos

Wall mount

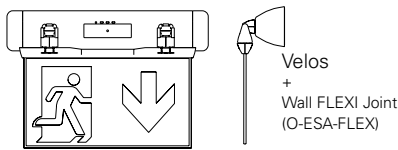

Velos + Wall FLEXI Joint (O-ESA-FLEX)

Recessed (30m)

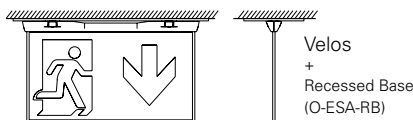

Velos + Recessed Base (O-ESA-RB)

Recessed (40m)

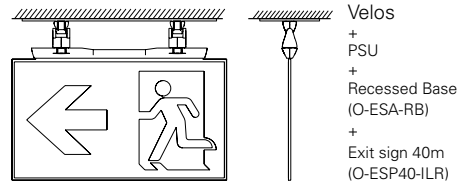

Velos + PSU + Recessed Base (O-ESA-RB) + Exit sign 40m (O-ESP40-ILR)

Back wall mount

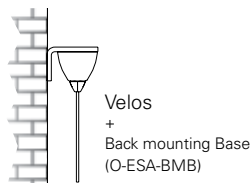

Velos + Back mounting Base (O-ESA-BMB)

Ceiling mount (40m)

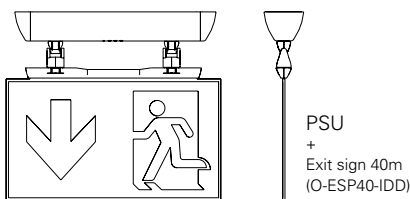

PSU + Exit sign 40m (O-ESP40-IDD)

Suspended with metal pipes

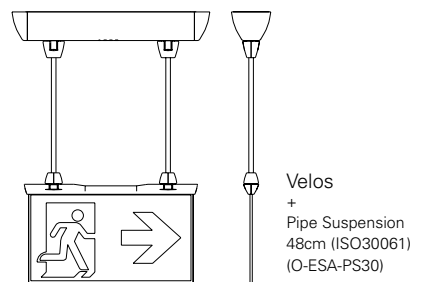

Velos + Pipe Suspension 48cm (ISO30061) (O-ESA-PS30)

Lateral mount



Velos + Lateral Base (O-ESA-LMB)

Suspended with adjustable rope

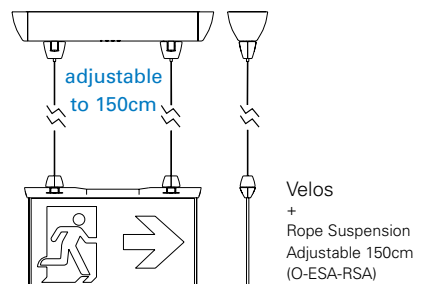







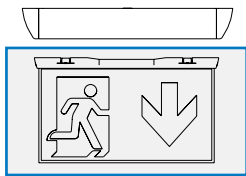





Velos + Rope Suspension Adjustable 150cm (O-ESA-RSA)

Accessories

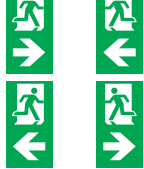



Order code	Description
O-ESA-RB	Velos Recessed base
O-ESA-FLEX	Velos Wall FLEXI Joint
O-ESA-RSA	Velos Rope Suspension adjustable 150cm
O-ESA-RSA-5M	Velos Rope Suspension adjustable 5m
O-ESA-PS30	Velos Pipe Suspension 48cm (ISO30061)
O-ESA-LMB	Velos Lateral Mounting Base
O-ESA-BMB	Velos Back Mounting Base



Exit sign of Velos

Order code	Description		Dimensions	
O-ESP-ILR	Velos pictogram ISO LEFT/RIGHT 30m	24 LEDs	288x165	
O-ESP-ID	Velos pictogram ISO DOWN/BLANK 30m	24 LEDs	288x165	
O-ESP-IDD	Velos pictogram ISO DOWN/DOWN 30m	24 LEDs	288x165	
O-ESP-IU	Velos pictogram ISO UP/BLANK 30m	24 LEDs	288x165	
O-ESP-IUU	Velos pictogram ISO UP/UP 30m	24 LEDs	288x165	
O-ESP-I2R	Velos pictogram ISO Lateral to Room	24 LEDs	288x165	
O-ESP-I2W	Velos pictogram ISO Lateral to Wall	24 LEDs	288x165	
O-ESP-H	Velos Hydrant pictogram 30m	24 LEDs	288x165	
O-ESP-FHD	Velos Fire hose down 30m	24 LEDs	288x165	
O-ESP-FH-EXT	Velos Fire hose & extinguisher 30m	24 LEDs	288x165	
O-ESP-WILR	Velos pictogram Wheel ISO LEFT/RIGHT 30m	24 LEDs	288x165	
O-ESP-WIDD	Velos pictogram Wheel ISO DOWN/DOWN 30m	24 LEDs	288x165	

Additional pictograms available

Order code	Description		Dimensions	
O-ESP40-ILR	Velos pictogram ISO LEFT/RIGHT 40m	24 LEDs	370x220	
O-ESP40-IDD	Velos pictogram ISO DOWN/DOWN 40m	24 LEDs	370x220	
O-ESP40-WILR	Velos pictogram Wheel ISO LEFT/RIGHT 40m	24 LEDs	370x220	
O-ESP40-WIDD	Velos pictogram Wheel ISO DOWN/DOWN 40m	24 LEDs	370x220	

Additional pictograms available