

Autoportante
Gama de acero | Acero
Combinable, puerta doble | MCD

IP 55 | TYPE 12, 13 | IK 10



**Material:**

Marco: Chapa de acero pintada de 1,5 mm. Puertas: Chapa de acero pintada de 2 mm. Paneles laterales, posterior y techo: Chapa de acero pintada de 1,5 mm. Placa de montaje: Chapa de acero galvanizado de 3 mm. Tapas inferiores: Chapa de acero galvanizado de 1 mm.

Estructura:

Perfiles abiertos soldados con patrón de taladro de 25 mm según DIN 43660. Incluye patrón de taladros exteriores.

Puertas:

Puertas montadas sobre la estructura con cuatro bisagras. Incluye el refuerzo de puerta con taladros a 25 mm. La puerta estándar no puede invertirse. La puerta con cierre a la izquierda ha de pedirse por separado.

Panel posterior:

Fijado con tornillos Torx M6. Posibilidad de montaje de puertas posteriores. Paneles posteriores separados en armarios de ancho 1600 mm.

Paneles laterales:

Suministrado como accesorio.

Techo:

Desmontable.

Cierre:

Cierre de varillas con 4 puntos de fijación en la puerta principal y sistema de cierre de dos puntos de fijación en la puerta esclava. Inserto estándar de doble paletón 3 mm. Se puede intercambiar por insertos estándar o Euro-cilindro y una manecilla elevadora.

Tapas inferiores:

Consta de tres o cuatro piezas (P>600).

Placa de montaje:

Doble plegado y ajustable en profundidad en pasos de 25 mm con el accesorio MPD02. Preparación interior para armarios de 1600 mm de ancho.

Puesta a tierra:

Todos los paneles se ponen a tierra a través de sus accesorios y se equipan con una toma de tierra separada.

Acabado:

Pintado al polvo, texturado, RAL 7035.

Protección:

Corresponde con IP 55 | TYPE 12, 13 | IK 10.

Certificaciones:

CE, CSA, DNV-GL, EAC, GOST, Kema Keur, Lloyds shipping, RS, cULus_listed.

Instrucciones de montaje:

Versión estándar preparada para instalación combinada. Para una instalación de armario único añadida paneles laterales.

Suministro:

Armario con puertas montadas, panel posterior, panel superior, tapas inferiores, placa de montaje y marco de refuerzo de puerta. El suministro también incluye pernos de puesta a tierra. Suministrado sobre un palet con ancho idéntico al armario que facilita el montaje sin desmontarlo. Todo el material de embalaje es reciclable.



Tabla de dimensiones | MCD

IP 55 | TYPE 12, 13 | IK 10

Con placa de montaje



Dimensión del armario			Dimensión de la placa de montaje		Profundidad útil	Ref.
A	An	P	a	an	p	
1800	800	500	1694	694	459	MCD18085R5
1800	1000	400	1694	894	359	MCD18104R5
1800	1000	500	1694	894	459	MCD18105R5
1800	1200	400	1694	1094	359	MCD18124R5
1800	1200	500	1694	1094	459	MCD18125R5
1800	1200	600	1694	1094	559	MCD18126R5
1800	1600	400	1694	1494	359	MCD18164R5
2000	800	500	1894	694	459	MCD20085R5
2000	1000	400	1894	894	359	MCD20104R5
2000	1000	500	1894	894	459	MCD20105R5
2000	1000	600	1894	894	559	MCD20106R5
2000	1000	800	1894	894	759	MCD20108R5
2000	1200	400	1894	1094	359	MCD20124R5
2000	1200	500	1894	1094	459	MCD20125R5
2000	1200	600	1894	1094	559	MCD20126R5
2000	1200	800	1894	1094	759	MCD20128R5
2000	1600	400	1894	1494	359	MCD20164R5
2000	1600	500	1894	1494	459	MCD20165R5
2000	1600	600	1894	1494	559	MCD20166R5
2200	1000	600	2094	894	559	MCD22106R5
2200	1200	600	2094	1094	559	MCD22126R5

Sin placa de montaje

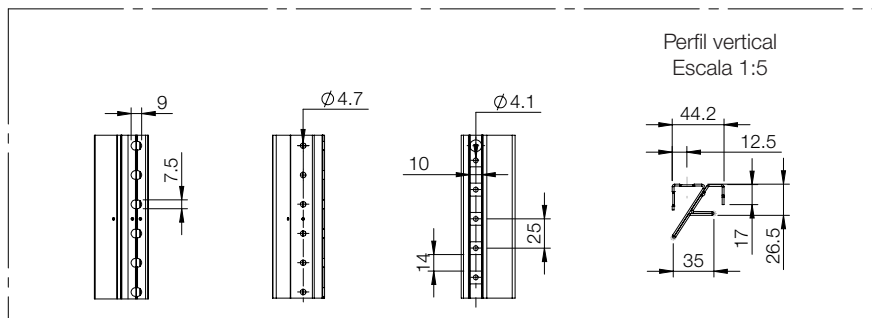
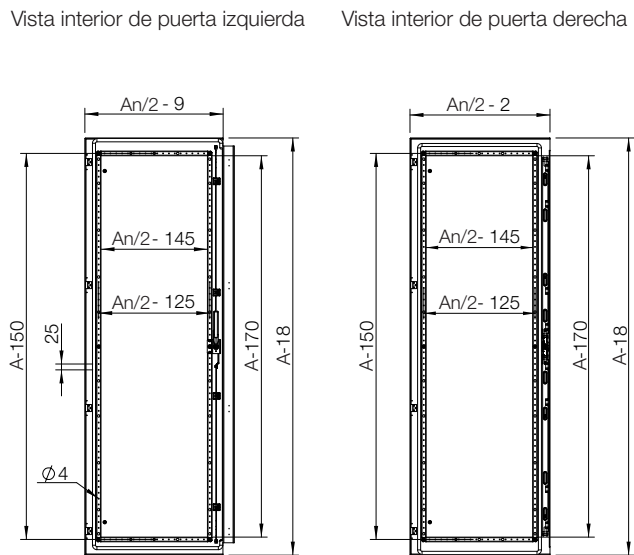
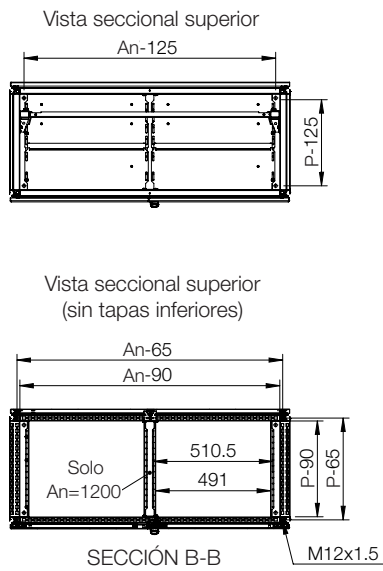
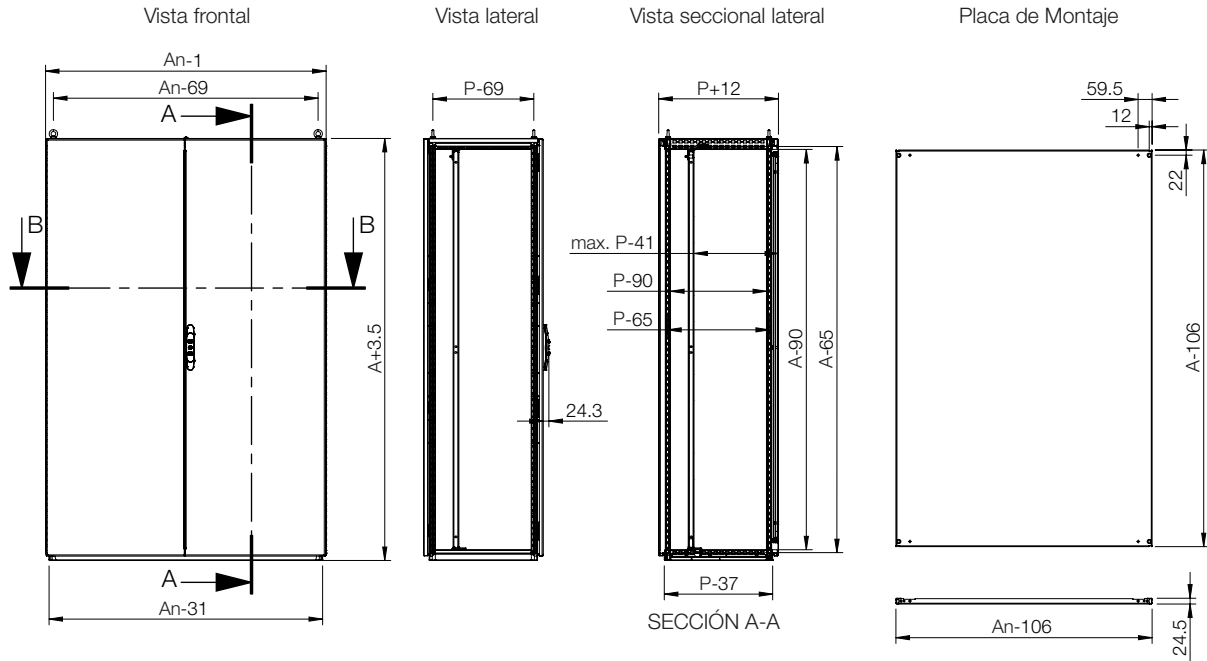
Dimensión del armario			Ref.
A	An	P	
1800	800	500	MCD18085PER5
1800	1000	400	MCD18104PER5
1800	1000	500	MCD18105PER5
1800	1200	400	MCD18124PER5
1800	1200	500	MCD18125PER5
1800	1200	600	MCD18126PER5
1800	1600	400	MCD18164PER5
2000	800	500	MCD20085PER5
2000	1000	400	MCD20104PER5
2000	1000	500	MCD20105PER5
2000	1000	600	MCD20106PER5
2000	1000	800	MCD20108PER5
2000	1200	400	MCD20124PER5
2000	1200	500	MCD20125PER5
2000	1200	600	MCD20126PER5
2000	1200	800	MCD20128PER5
2000	1600	400	MCD20164PER5
2000	1600	500	MCD20165PER5
2000	1600	600	MCD20166PER5
2200	1000	600	MCD22106PER5
2200	1200	600	MCD22126PER5



Matriz de selección de accesorios | MCD

						
Armario				Montaje		
	Alt.	Anch.	P	Placa de montaje	Placa de montaje ancha *	Perfiles deslizantes transversales
MCD18085R5	1800	800	500	MP1808	MPW1808	MTS800
MCD18104R5	1800	1000	400	MP1810	MPW1810	MTS1000
MCD18105R5	1800	1000	500	MP1810	MPW1810	MTS1000
MCD18124R5	1800	1200	400	MP1812	MPW1812	MTS1200
MCD18125R5	1800	1200	500	MP1812	MPW1812	MTS1200
MCD18126R5	1800	1200	600	MP1812	MPW1812	MTS1200
MCD18164R5	1800	1600	400	MP1816	MPW1816	MTS1600
MCD20085R5	2000	800	500	MP2008	MPW2008	MTS800
MCD20104R5	2000	1000	400	MP2010	MPW2010	MTS1000
MCD20105R5	2000	1000	500	MP2010	MPW2010	MTS1000
MCD20106R5	2000	1000	600	MP2010	MPW2010	MTS1000
MCD20108R5	2000	1000	800	MP2010	MPW2010	MTS1000
MCD20124R5	2000	1200	400	MP2012	MPW2012	MTS1200
MCD20125R5	2000	1200	500	MP2012	MPW2012	MTS1200
MCD20126R5	2000	1200	600	MP2012	MPW2012	MTS1200
MCD20128R5	2000	1200	800	MP2012	MPW2012	MTS1200
MCD20164R5	2000	1600	400	MP2016	MPW2016	MTS1600
MCD20165R5	2000	1600	500	MP2016	MPW2016	MTS1600
MCD20166R5	2000	1600	600	MP2016	MPW2016	MTS1600
MCD22106R5	2200	1000	600	MP2210	-	-
MCD22126R5	2200	1200	600	MP2212	-	-

* Se necesita MTS.

Armario	Montaje								
	Alt.	Anch.	P	Perfil de montaje, Alt.	Perfil de montaje, Anch.	Perfil de montaje, P.	Perfil con sistema de clic, Anch.	Perfil con sistema de clic, P.	Barras de montaje lateral
MCD18085R5	1800	800	500	CLPF1800	CLPF800	CLPF500	CLPK800	CLPK500	CMB502
MCD18104R5	1800	1000	400	CLPF1800	CLPF1000	CLPF400	CLPK1000	CLPK400	CMB402
MCD18105R5	1800	1000	500	CLPF1800	CLPF1000	CLPF500	CLPK1000	CLPK500	CMB502
MCD18124R5	1800	1200	400	CLPF1800	CLPF1200	CLPF400	CLPK1200	CLPK400	CMB402
MCD18125R5	1800	1200	500	CLPF1800	CLPF1200	CLPF500	CLPK1200	CLPK500	CMB502
MCD18126R5	1800	1200	600	CLPF1800	CLPF1200	CLPF600	CLPK1200	CLPK600	CMB602
MCD18164R5	1800	1600	400	CLPF1800	CLPF1600	CLPF400	-	CLPK400	CMB402
MCD20085R5	2000	800	500	CLPF2000	CLPF800	CLPF800	CLPK800	CLPK800	CMB502
MCD20104R5	2000	1000	400	CLPF2000	CLPF1000	CLPF400	CLPK1000	CLPK400	CMB402
MCD20105R5	2000	1000	500	CLPF2000	CLPF1000	CLPF500	CLPK1000	CLPK500	CMB502
MCD20106R5	2000	1000	600	CLPF2000	CLPF1000	CLPF600	CLPK1000	CLPK600	CMB602
MCD20108R5	2000	1000	800	CLPF2000	CLPF1000	CLPF800	CLPK1000	CLPK800	CMB802
MCD20124R5	2000	1200	400	CLPF2000	CLPF1200	CLPF400	CLPK1200	CLPK400	CMB402
MCD20125R5	2000	1200	500	CLPF2000	CLPF1200	CLPF500	CLPK1200	CLPK500	CMB502
MCD20126R5	2000	1200	600	CLPF2000	CLPF1200	CLPF600	CLPK1200	CLPK600	CMB602
MCD20128R5	2000	1200	800	CLPF2000	CLPF1200	CLPF800	CLPK1200	CLPK800	CMB802
MCD20164R5	2000	1600	400	CLPF2000	CLPF1600	CLPF400	-	CLPK400	CMB402
MCD20165R5	2000	1600	500	CLPF2000	CLPF1600	CLPF500	-	CLPK500	CMB502
MCD20166R5	2000	1600	600	CLPF2000	CLPF1600	CLPF600	-	CLPK600	CMB602
MCD22106R5	2200	1000	600	CLPF2200	CLPF1000	CLPF600	CLPK1000	CLPK600	CMB602
MCD22126R5	2200	1200	600	CLPF2200	CLPF1200	CLPF600	CLPK1200	CLPK600	CMB602

Matriz de selección de accesorios | MCD

Armario				Montaje			Puertas	
Alt.	Anch.	P	Barra divisora de profund.	Barra divisora vertical	Soportes de fijación	Puerta opaca, izquierda *	Puerta opaca, derecha *	
MCD18085R5	1800	800	500	VBD500	VB1800	VBK04	DN1804LR5	DN1804RR5
MCD18104R5	1800	1000	400	VBD400	VB1800	VBK04	DN1805LR5	DN1805RR5
MCD18105R5	1800	1000	500	VBD500	VB1800	VBK04	DN1805LR5	DN1805RR5
MCD18124R5	1800	1200	400	VBD400	VB1800	VBK1200	DN1806LR5	DN1806RR5
MCD18125R5	1800	1200	500	VBD500	VB1800	VBK1200	DN1806LR5	DN1806RR5
MCD18126R5	1800	1200	600	VBD600	VB1800	VBK1200	DN1806LR5	DN1806RR5
MCD18164R5	1800	1600	400	VBD400	VB1800	VBK1600	DN1808LR5	DN1808RR5
MCD20085R5	2000	800	500	VBD500	VB2000	VBK04	DN2004LR5	DN2004RR5
MCD20104R5	2000	1000	400	VBD400	VB2000	VBK04	DN2005LR5	DN2005RR5
MCD20105R5	2000	1000	500	VBD500	VB2000	VBK04	DN2005LR5	DN2005RR5
MCD20106R5	2000	1000	600	VBD600	VB2000	VBK04	DN2005LR5	DN2005RR5
MCD20108R5	2000	1000	800	VBD800	VB2000	VBK04	DN2005LR5	DN2005RR5
MCD20124R5	2000	1200	400	VBD400	VB2000	VBK1200	DN2006LR5	DN2006RR5
MCD20125R5	2000	1200	500	VBD500	VB2000	VBK1200	DN2006LR5	DN2006RR5
MCD20126R5	2000	1200	600	VBD600	VB2000	VBK1200	DN2006LR5	DN2006RR5
MCD20128R5	2000	1200	800	VBD800	VB2000	VBK1200	DN2006LR5	DN2006RR5
MCD20164R5	2000	1600	400	VBD400	VB2000	VBK1600	DN2008LR5	DN2008RR5
MCD20165R5	2000	1600	500	VBD500	VB2000	VBK1600	DN2008LR5	DN2008RR5
MCD20166R5	2000	1600	600	VBD600	VB2000	VBK1600	DN2008LR5	DN2008RR5
MCD22106R5	2200	1000	600	VBD600	VB2200	VBK1200	DN2205LR5	DN2205RR5
MCD22126R5	2200	1200	600	VBD600	VB2200	VBK1200	DN2206LR5	DN2206RR5

* Se necesita DNMK para una puerta adicional.

Armario	Fijación			Térmico					
	Alt.	Anch.	P	Zócalos delantero/trasero (100 mm de altura)	Paneles laterales de base (100 mm de altura)	Zócalos delantero/trasero (200 mm de altura)	Paneles laterales de base (200 mm de altura)	Zócalo delantero/trasero ventilado (100 mm de altura)	Techo ventilado
MCD18085R5	1800	800	500	PF1080	PS1050	PF2080	PS2050	PV1080	CVR0805R5
MCD18104R5	1800	1000	400	PF1100	PS1040	PF2100	PS2040	PV1100	CVR1004R5
MCD18105R5	1800	1000	500	PF1100	PS1050	PF2100	PS2050	PV1100	CVR1005R5
MCD18124R5	1800	1200	400	PF1120	PS1040	PF2120	PS2040	PV1120	CVR1204R5
MCD18125R5	1800	1200	500	PF1120	PS1050	PF2120	PS2050	PV1120	CVR1205R5
MCD18126R5	1800	1200	600	PF1120	PS1060	PF2120	PS2060	PV1120	CVR1206R5
MCD18164R5	1800	1600	400	2x PF1080	PS1040	2x PF2080	PS2040	2x PV1080	CVR1604R5
MCD20085R5	2000	800	500	PF1080	PS1050	PF2080	PS2050	PV1080	CVR0805R5
MCD20104R5	2000	1000	400	PF1100	PS1040	PF2100	PS2040	PV1100	CVR1004R5
MCD20105R5	2000	1000	500	PF1100	PS1050	PF2100	PS2050	PV1100	CVR1005R5
MCD20106R5	2000	1000	600	PF1100	PS1060	PF2100	PS2060	PV1100	CVR1006R5
MCD20108R5	2000	1000	800	PF1100	PS1080	PF2100	PS2080	PV1100	CVR1008R5
MCD20124R5	2000	1200	400	PF1120	PS1040	PF2120	PS2040	PV1120	CVR1204R5
MCD20125R5	2000	1200	500	PF1120	PS1050	PF2120	PS2050	PV1120	CVR1205R5
MCD20126R5	2000	1200	600	PF1120	PS1060	PF2120	PS2060	PV1120	CVR1206R5
MCD20128R5	2000	1200	800	PF1120	PS1080	PF2120	PS2080	PV1120	CVR1208R5
MCD20164R5	2000	1600	400	2x PF1080	PS1040	2x PF2080	PS2040	2x PV1080	CVR1604R5
MCD20165R5	2000	1600	500	2x PF1080	PS1050	2x PF2080	PS2050	2x PV1080	CVR1605R5
MCD20166R5	2000	1600	600	2x PF1080	PS1060	2x PF2080	PS2060	2x PV1080	CVR1606R5
MCD22106R5	2200	1000	600	PF1100	PS1060	PF2100	PS2060	PV1100	CVR1006R5
MCD22126R5	2200	1200	600	PF1120	PS1060	PF2120	PS2060	PV1120	CVR1206R5

Armario				Fijación		Cable		
Alt.	Anch.	P	Paneles laterales	Placa separadora *	Barra de fijación de cables (montada bajo las placas inferiores)	Barra de fijación de cables (montada sobre las placas inferiores)	Tapas inferiores ventiladas	
MCD18085R5	1800	800	500	SPM1805R5	SPD1805	CABP800	CAB800	CVB0805
MCD18104R5	1800	1000	400	SPM1804R5	SPD1804	CABP1000	CAB1000	CVB1004
MCD18105R5	1800	1000	500	SPM1805R5	SPD1805	CABP1000	CAB1000	CVB1005
MCD18124R5	1800	1200	400	SPM1804R5	SPD1804	CABP1200	CAB1200	-
MCD18125R5	1800	1200	500	SPM1805R5	SPD1805	CABP1200	CAB1200	-
MCD18126R5	1800	1200	600	SPM1806R5	SPD1806	CABP1200	CAB1200	CVB1206
MCD18164R5	1800	1600	400	SPM1804R5	SPD1804	CABP800	CAB800	CVB0804
MCD20085R5	2000	800	500	SPM2005R5	SPD2005	CABP800	CAB800	CVB0805
MCD20104R5	2000	1000	400	SPM2004R5	SPD2004	CABP1000	CAB1000	CVB1004
MCD20105R5	2000	1000	500	SPM2005R5	SPD2005	CABP1000	CAB1000	CVB1005
MCD20106R5	2000	1000	600	SPM2006R5	SPD2006	CABP1000	CAB1000	CVB1006
MCD20108R5	2000	1000	800	SPM2008R5	SPD2008	CABP1000	CAB1000	CVB1008
MCD20124R5	2000	1200	400	SPM2004R5	SPD2004	CABP1200	CAB1200	-
MCD20125R5	2000	1200	500	SPM2005R5	SPD2005	CABP1200	CAB1200	-
MCD20126R5	2000	1200	600	SPM2006R5	SPD2006	CABP1200	CAB1200	CVB1206
MCD20128R5	2000	1200	800	SPM2008R5	SPD2008	CABP1200	CAB1200	CVB1208
MCD20164R5	2000	1600	400	SPM2004R5	SPD2004	CABP800	CAB800	CVB0804
MCD20165R5	2000	1600	500	SPM2005R5	SPD2005	CABP800	CAB800	CVB0805
MCD20166R5	2000	1600	600	SPM2006R5	SPD2006	CABP800	CAB800	CVB0806
MCD22106R5	2200	1000	600	SPM2206R5	SPD2206	CABP1000	CAB1000	CVB1006
MCD22126R5	2200	1200	600	SPM2206R5	SPD2206	CABP1200	CAB1200	-

* Se necesita CCJ.