

PAPER TOWEL DISPENSER PP113



265 x 298 x 120 mm

approx. 500 paper towels

- Paper towel dispenser in robust, germ-reducing and easy-care stainless steel (AISI 304).
- All-stainless steel housing with rounded vertical corners. Visible surfaces satin finished and brushed. Further available surfaces: see below.
- Designed for approx. 500 standard paper towels in zigzag fold. Paper size (folded): 240-250 mm x 100-115 mm.
- Inspection slot to indicate fill level.
- Accessible for refilling through lockable, hinged housing.
- Keyed alike cylinder lock in corrosion-resistant zinc die-casting.
- Wear parts can be replaced as modules.
- Mounting: With four screws through key holes and one optional anti-theft hole in the back wall.
- Delivery includes fixing material.
- Weight, including single package: 2.3 kg



Suggested text for specifications:

Paper towel dispenser in stainless steel (AISI 304) for surface mounting. All-stainless steel housing with rounded vertical corners. Visible surfaces satin finished and brushed. Filling quantity approx. 500 paper towels. Inspection slot to indicate fill level. Accessible for refilling through lockable, hinged housing. Keyed alike cylinder lock in corrosion-resistant zinc die-casting. Delivery includes fixing material.

Dimensions: 265 x 298 x 120 mm

Article No. PP113

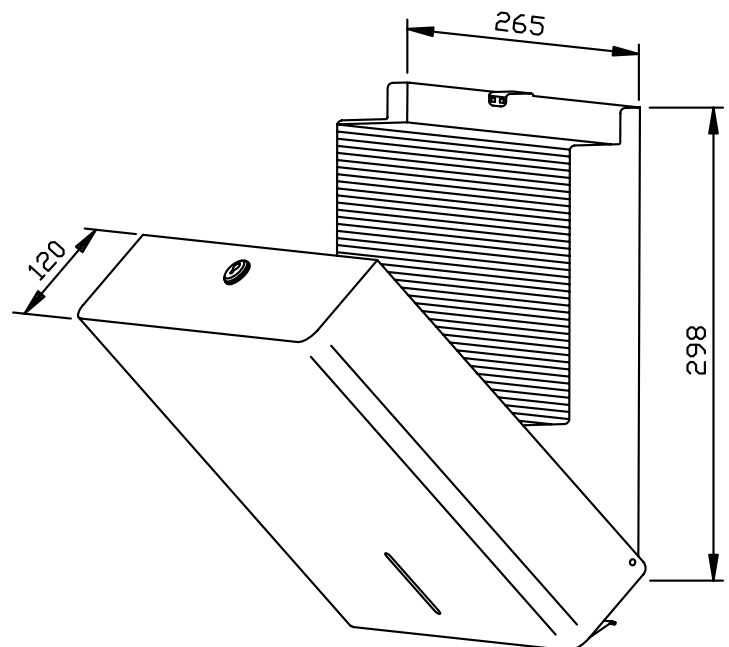

Available surfaces	ID No.
satin finished (standard)	727 540
highly polished	731 540
(coloured) plastic powder-coating	728 540

Ernst Wagner GmbH & Co. KG

Ernst-Abbe-Straße 21 · D-72770 Reutlingen · Tel.: +49712151539-0 · Fax: -20
info@wagner-ewar.de · www.wagner-ewar.de

WAGNER
EWAR