

● ● ● Price index

IPA Qualification Certificate Air
Cleanless Class ISO Class 3
(at v = 2 m/s) upon request

ESD classification:
Electrically conductive ESD/ATEX
version upon request

UL94 V2 classifications
upon request



Snap-open mechanism, choice of snap-open on left or right. Hinged crossbar can be swiveled by more than 180° on both sides. Lightning-fast closing by hand. Secure fit without additional locking devices.



When to use the Series 3400/3450/3480/3500:

- Snap-open accessibility along both radii
- If integrated strain relief is required at the connection point
- Modular interior separation
- If long service life is required
- If easy installation is required
- If half E-Tube is required (Series 3450)
- If fully enclosed E-Tube is required (Series 3480)



When not to use it:

- If maximum stability is required
▶ **System E4.1, Series E4.2, page 7.48**
- If the application is very simple
▶ **Easy Chain®, Series E300, page 3.52**

- ❶ Opening system for rapid opening, either from the right or the left
- ❷ Lateral glide surfaces for side-mounted operation
- ❸ Half E-Tube Series 3450
- ❹ Tried-and-tested mounting bracket
- ❺ Series 3400 and 3450 snap-open along inner radius
- ❻ Integrated strain relief possible
- ❼ Double stop dog for long unsupported length
- ❽ Cross bars with high locking range
- ❾ Fully enclosed E-Tube Series 3480
- ❿ Modular interior separation
- ⓫ Easy assembly by optimized pin
- ⓬ Also available as ESD version
- ⓭ **Strain relief separator** - Separator with integrated strain relief ▶ [page 5.136](#)

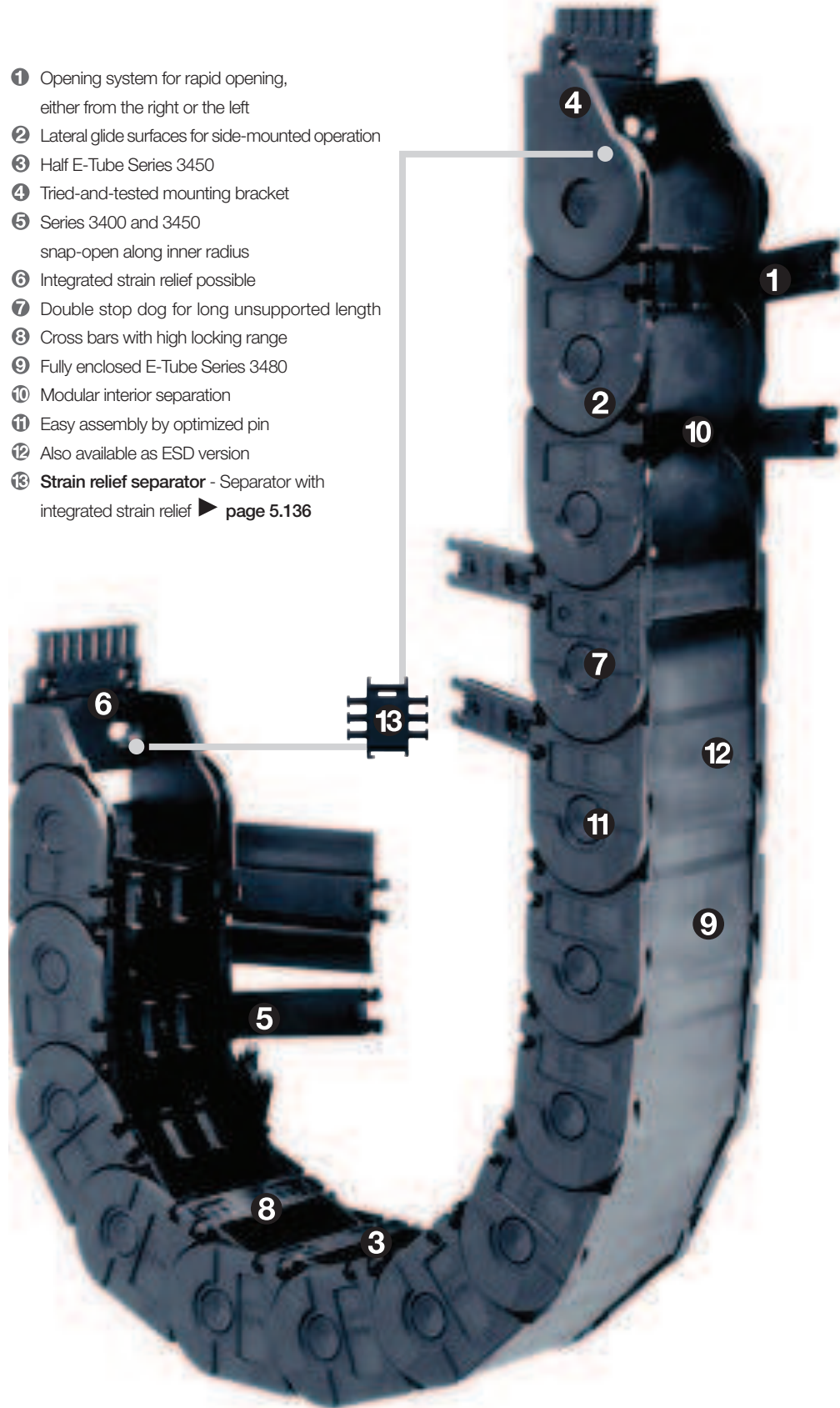

Order example complete E-Chain®

Please indicate chain-lengths or number of links **Example: 3 m or 45 links**

3 m **3400.150.100.0**

E-Chain®

with 2 separators **311** assembled every 2nd link

Interior separation

1 set **3150.34PZB**

Mounting bracket



Unsupported length

FL_G = with straight upper run
 FL_B = with permitted sag
 Further information ► **Design, page 1.12**

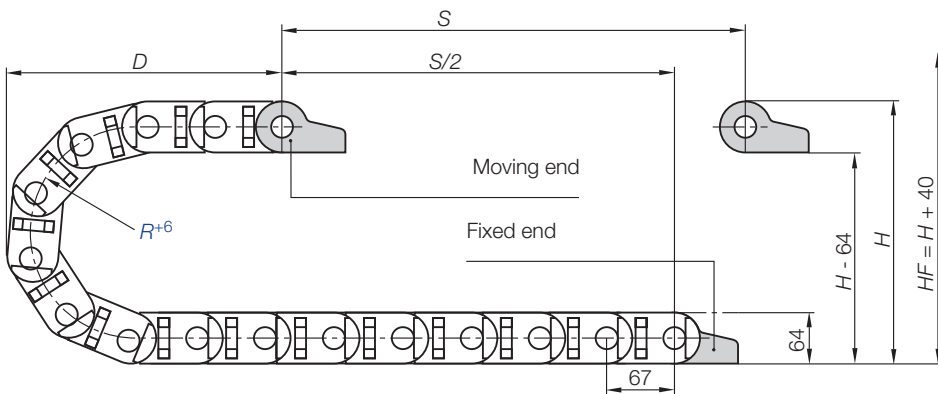
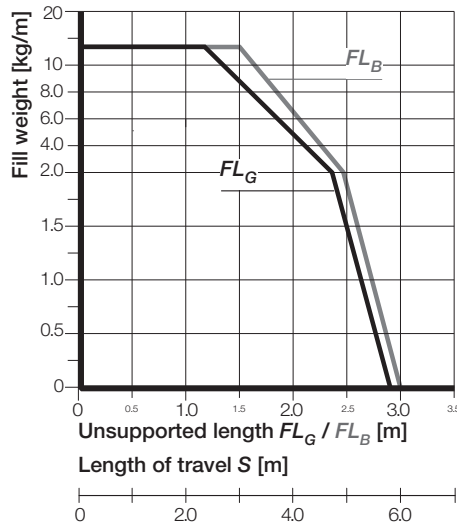
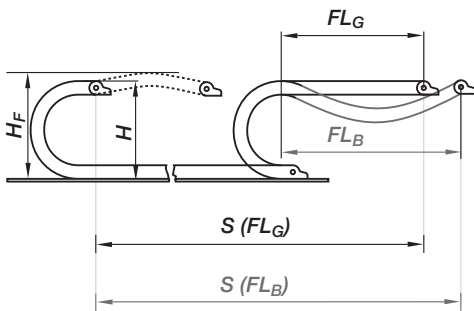

Pitch = 67 mm/link Links/m = 15 (1005 mm) Chain length = $S/2 + K$

R	075*	100*	125	150	200	250	300
H	215	265	315	365	465	565	665
D	150	200	225	250	300	350	400
K	400	500	650	725	875	1050	1225
H ₂	215	265	186	186	186	186	186
D ₂ ⁺²⁵	150	200	475	570	780	1010	1150
K ₂	400	500	804	1005	1340	1675	1943

*for Series 3450/3480 upon request

S = Length of travel
 R = Bending radius
 H = Nominal clearance height
 H_F = Required clearance height
 H_{RI} = Trough inner height
 D = Overlength E-Chain® radius in final position
 $K = \pi \cdot R + \text{"safety"}$
 D_2 = Over length - long travels, gliding
 K_2 = *Further add-on
 H_2 = *Mounting height
 *if the mounting bracket location is set lower

Other installation methods

- Vertical, hanging ≤ 80 m
- Vertical, standing ≤ 3 m
- Side mounted, unupp. ≤ 1 m
- Rotary requires further calculation
- Unsupported length of upper run = upon request



Short travels - unsupported

Unsupported E-Chains® feature positive camber over short travels. This must be accounted for when specifying the clearance height H_F . Please consult igus® if space is particularly restricted.

The required clearance height:
 $H_F = H + 40$ mm
 (with 2,5 kg/m fill weight)

Long travel lengths from 10 m to max. 150 m Chain length = $S/2 + K_2$

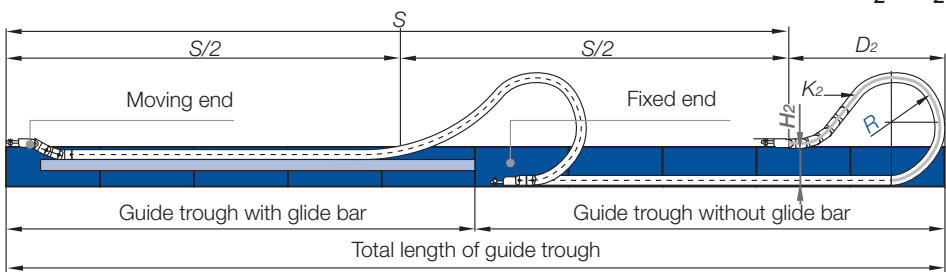

In case of travels between 4 and 10 m we recommend a longer unsupported length.



Gliding, long travel applications (max. 150 m)

In this case the E-Chain® upper run will be introduced in a guide trough on the lower run. We recommend to realize the engineering of such a plant by our technicians.

Speed / acceleration FL_G	max. 20 [m/s] / max. 200 [m/s ²]
Speed / acceleration FL_B	max. 3 [m/s] / max. 6 [m/s ²]
Gliding speed / acceleration (maximum)	max. 10 [m/s] / max. 50 [m/s ²]
Material - permitted temperature °C	igumid G / -40° up to +120° C
Flammability class, igumid G	VDE 0304 IIC UL94 HB

Technical Data



Details of material properties
 ► page 1.38

For support of the lower run - **Support Tray tool kit** available ► page 9.70

E2/000 medium
 Inner height: 45 mm

Phone +49- (0) 22 03-96 49-800
 Fax +49- (0) 22 03-96 49-222



► page 5.91

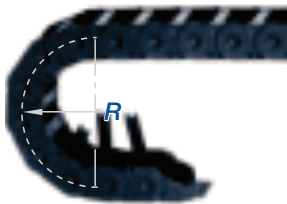
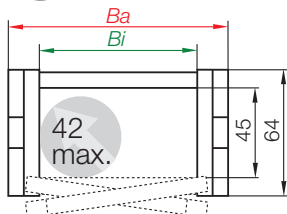

Series 3400 - E-Chain® - snap-open along inner radius

Part No.	<i>Bi</i> [mm]	<i>Ba</i> [mm]	<i>R</i> [mm]	Bending radii						Weight [kg/m]
3400.050.□.0	50	70	075	100	125	150	200	250	300	≈ 1,60
3400.075.□.0	75	95	075	100	125	150	200	250	300	≈ 1,78
3400.100.□.0	100	120	075	100	125	150	200	250	300	≈ 1,93
3400.115.□.0	115	135	075	100	125	150	200	250	300	≈ 1,99
3400.125.□.0	125	145	075	100	125	150	200	250	300	≈ 2,03
3400.150.□.0	150	170	075	100	125	150	200	250	300	≈ 2,17
3400.175.□.0	175	195	075	100	125	150	200	250	300	≈ 2,28
3400.200.□.0	200	220	075	100	125	150	200	250	300	≈ 2,45
3400.225.□.0	225	245	075	100	125	150	200	250	300	≈ 2,59
3400.250.□.0	250	270	075	100	125	150	200	250	300	≈ 2,73

Part No. structure

3400.075.075.0



Supplement Part No. with required radius. Example: 3400.050.075.0

0 = standard color, other colors ▶ page 1.39 · Pitch = 67 mm/link - Links/m = 15

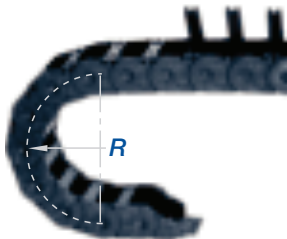
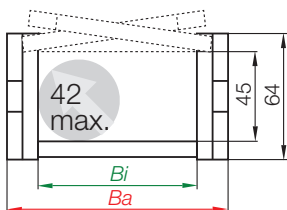

Series 3500 - E-Chain® - snap-open along outer radius - Standard!

Part No.	<i>Bi</i> [mm]	<i>Ba</i> [mm]	<i>R</i> [mm]	Bending radii						Weight [kg/m]
3500.050.□.0	50	70	075	100	125	150	200	250	300	≈ 1,60
3500.075.□.0	75	95	075	100	125	150	200	250	300	≈ 1,78
3500.100.□.0	100	120	075	100	125	150	200	250	300	≈ 1,93
3500.115.□.0	115	135	075	100	125	150	200	250	300	≈ 1,99
3500.125.□.0	125	145	075	100	125	150	200	250	300	≈ 2,03
3500.150.□.0	150	170	075	100	125	150	200	250	300	≈ 2,17
3500.175.□.0	175	195	075	100	125	150	200	250	300	≈ 2,28
3500.200.□.0	200	220	075	100	125	150	200	250	300	≈ 2,45
3500.225.□.0	225	245	075	100	125	150	200	250	300	≈ 2,59
3500.250.□.0	250	270	075	100	125	150	200	250	300	≈ 2,73

Part No. structure

3500.075.075.0



Supplement Part No. with required radius. Example: 3500.050.075.0

0 = standard color, other colors ▶ page 1.39 · Pitch = 67 mm/link - Links/m = 15



Series 3450 - half E-Tube - snap-open along inner radius

Part No.	Bi [mm]	Ba [mm]	R [mm]	Bending radii	Weight [kg/m]
3450.050.□.0	50	70	125	150 200 250 300	≈ 1,77
3450.075.□.0	75	95	125	150 200 250 300	≈ 1,95
3450.100.□.0	100	120	125	150 200 250 300	≈ 2,15
3450.115.□.0	115	135	125	150 200 250 300	≈ 2,30
3450.125.□.0	125	145	125	150 200 250 300	≈ 2,42
3450.150.□.0	150	170	125	150 200 250 300	≈ 2,60
3450.175.□.0	175	195	125	150 200 250 300	≈ 2,75
3450.200.□.0	200	220	125	150 200 250 300	≈ 2,90
3450.225.□.0	225	245	125	150 200 250 300	≈ 3,15
3450.250.□.0	250	270	125	150 200 250 300	≈ 3,30

The widths **Bi 50/125/150/200/250** are available upon request. Time of delivery approx. 6-8 weeks after order.

The bending radii **075 100** are available upon request.

Supplement Part No. with required radius. Example: 3450.050. **125**.0

0 = standard color, other colors ▶ page 1.39 · Pitch = 67 mm/link - Links/m = 15

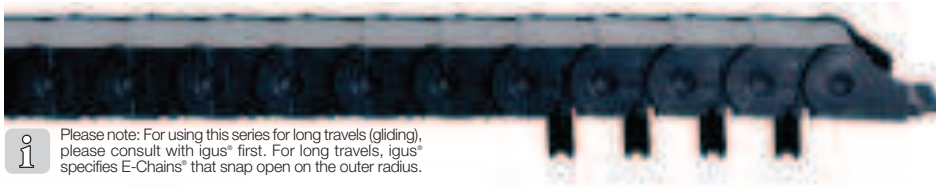

Please note: For using this series for long travels (gliding), please consult with igus® first. For long travels, igus® specifies E-Chains® that snap open on the outer radius.

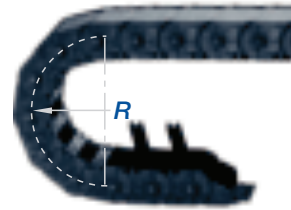
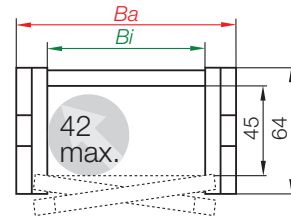

Part No. structure

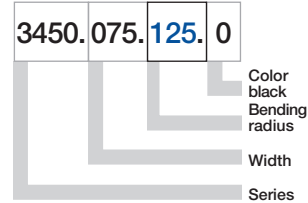

Series 3480 - E-Tube - snap-open along inner radius

Part No.	Bi [mm]	Ba [mm]	R [mm]	Bending radii	Weight [kg/m]
3480.050.□.0	50	70	125	150 200 250 300	≈ 1,96
3480.075.□.0	75	95	125	150 200 250 300	≈ 2,07
3480.100.□.0	100	120	125	150 200 250 300	≈ 2,30
3480.115.□.0	115	135	125	150 200 250 300	≈ 2,46
3480.125.□.0	125	145	125	150 200 250 300	≈ 2,49
3480.150.□.0	150	170	125	150 200 250 300	≈ 2,62
3480.175.□.0	175	195	125	150 200 250 300	≈ 2,80
3480.200.□.0	200	220	125	150 200 250 300	≈ 2,94
3480.225.□.0	225	245	125	150 200 250 300	≈ 3,12
3480.250.□.0	250	270	125	150 200 250 300	≈ 3,28

The widths **Bi 50/125/200/225/250** are available upon request. Time of delivery approx. 6-8 weeks after order.

The bending radii **075 100** are available upon request.

Supplement Part No. with required radius. Example: 3480.075. **150**.0

0 = standard color, other colors ▶ page 1.39 · Pitch = 67 mm/link - Links/m = 15

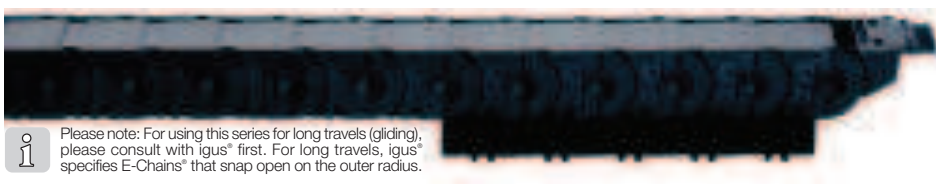

Please note: For using this series for long travels (gliding), please consult with igus® first. For long travels, igus® specifies E-Chains® that snap open on the outer radius.

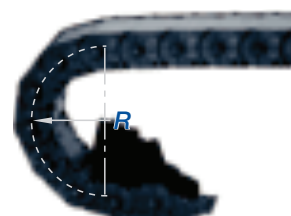
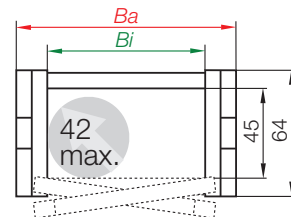

Part No. structure

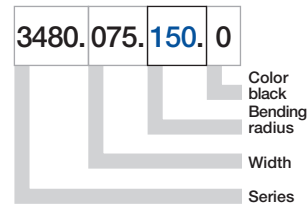

E2/000 medium
Inner height: 45 mm

Phone +49- (0) 22 03-96 49-800
Fax +49- (0) 22 03-96 49-222

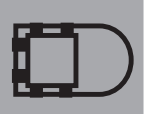

▶ page 5.91



Vertical Separator	
unassembled	301
assembled	311

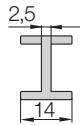

Spacer*	
unassembled	305.08
assembled	315.08
unassembled	305.12
assembled	315.12

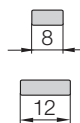

Strain Relief Separator	
unassembled	301.Z
assembled	311.Z

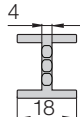

*For side-mounted applications

Option 1: Vertical Separators and Spacer for E-Chains®

Vertical Separators are used if a vertical subdivision of the E-Chain® interior is required - By standard Vertical Separators are assembled every other E-Chain® link

- **Standard** subdivision (Series 3400/Series 3500) with **Vertical Separator 311**, for combinations with **Full-Width Shelf 2210.X**
- If a broad distance shall be kept between the separators or they have to be fixed in their position, e.g. in case of side mounted applications, **Spacer 315.08** and **Spacer 315.12** can be used
- **Strain Relief Separator 301.Z**, integrable in the mounting bracket, to position at any point

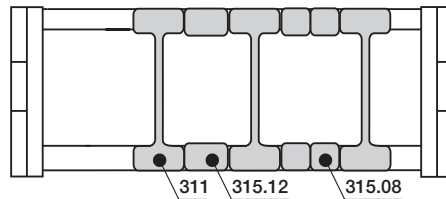

Vert. Separator, slotted	
unassembled	302
assembled	312

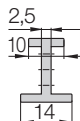

Vert. Separator, slotted	
unassembled	302.24
assembled	312.24

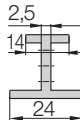

Option 2: Full-Width Shelves for E-Chains®

For applications involving many thin cables with similar or identical diameters

- **Vertical Separator, slotted 312** and **Vertical Separator, slotted 312.24** (with wide base, e.g. in case of side mounted applications) - for applications with **Full-Width Shelf 321.X**

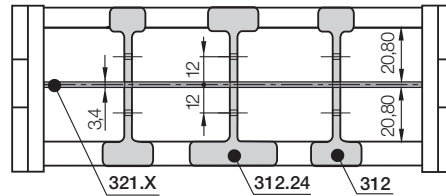

Full-Width Shelf	
X-1	
t = 3,4	

Width X [mm]	Part No. unassembled	Part No. assembled
050	320.050	321.050
075	320.075	321.075
100	320.100	321.100
115	320.115	321.115
125	320.125	321.125

Width X [mm]	Part No. unassembled	Part No. assembled
150	320.150	321.150
175	320.175	321.175
200	320.200	321.200
225	320.225	321.225
250	320.250	321.250

Side Plate	
unassembled	303
assembled	313

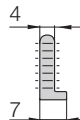

Middle Plate	
unassembled	304
assembled	314

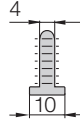

Slotted Separator, open	
unassembled	307
assembled	317

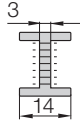

Option 3: Shelves for E-Chains®

For applications involving many cables with different diameters. The Shelves can be arranged elevator-shifted with different bottoms within the entire E-Chain® width

- **Shelf 2210.X** can be combined with **Middle Plate 314** and **Side Plate 313**
- Option 3 "Shelves" can also be combined with option 1 "Vertical Separators"
- Assembling of the **Slotted Separator, open 317** in the existing separation afterwards possible

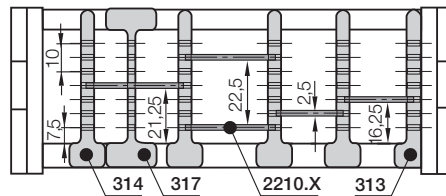

Shelf	
X	
X-7	
t = 2,5	

Width X [mm]	Part No. unassembled	Part No. assembled
018	2200.18	2210.18
023	2200.23	2210.23
028	2200.28	2210.28
033	2200.33	2210.33
038	2200.38	2210.38
043	2200.43	2210.43
048	2200.48	2210.48

Width X [mm]	Part No. unassembled	Part No. assembled
058	2200.58	2210.58
068	2200.68	2210.68
073	2200.73	2210.73
088	2200.88	2210.88
099	2200.99	2210.99
124	2200.124	2210.124
149	2200.149	2210.149

Option 4: Vertical Separators for E-Tubes

Vertical Separators are used if a vertical subdivision of the E-Tube interior is required -

By standard Vertical Separators are assembled every other E-Tube link

- Standard subdivision half E-Tube (Series 3450) and full E-Tube (Series 3480) with Vertical Separator 34511, for combinations with Full-Width Shelf 321.X
- Strain Relief Separator 34501.Z, integrable in the mounting bracket, to position at any point

Vert. Separator, slotted		
unassembled	34501	
assembled	34511	

Strain Relief Separator		
unassembled	34501.Z	
assembled	34511.Z	

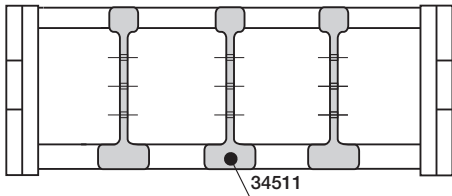

E2/000 medium
Inner height: 45 mm

Option 5: Full-Width Shelves for E-Tubes

For applications involving many thin cables with similar or identical diameters

- Vertical Separator, slotted 34511 - for applications with Full-Width Shelf 321.X

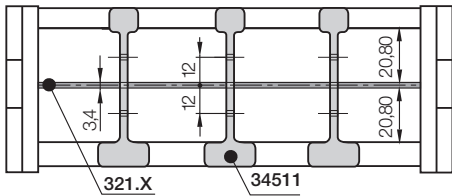

Width X [mm]	Part No. unassembled	Part No. assembled
050	320.050	321.050
075	320.075	321.075
100	320.100	321.100
115	320.115	321.115
125	320.125	321.125

Width X [mm]	Part No. unassembled	Part No. assembled
150	320.150	321.150
175	320.175	321.175
200	320.200	321.200
225	320.225	321.225
250	320.250	321.250

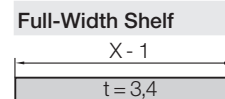

Phone +49- (0) 22 03-96 49-800
Fax +49- (0) 22 03-96 49-222

Option 6: Shelves for E-Tubes

For applications involving many cables with different diameters. The Shelves can be arranged elevator-shifted with different bottoms within the entire E-Chain® width

- Assembling of the Slotted Separator, open 317 in the existing separation afterwards possible
- Shelf 2210.X can be combined with Slotted Separator, open 317

Slotted Separator, open		
unassembled		
assembled	307	
		317

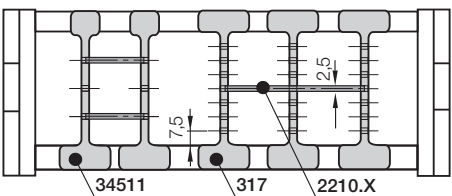

Width X [mm]	Part No. unassembled	Part No. assembled
018	2200.18	2210.18
023	2200.23	2210.23
028	2200.28	2210.28
033	2200.33	2210.33
038	2200.38	2210.38
043	2200.43	2210.43
048	2200.48	2210.48

Width X [mm]	Part No. unassembled	Part No. assembled
058	2200.58	2210.58
068	2200.68	2210.68
073	2200.73	2210.73
088	2200.88	2210.88
099	2200.99	2210.99
124	2200.124	2210.124
149	2200.149	2210.149

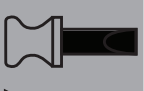
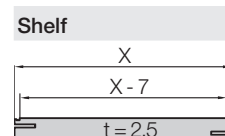

▶ page 5.91

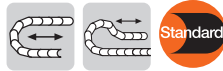

The Standard - option polymer - pivoting

- Recommended for unsupported and gliding applications
- Well suited for tight installation conditions
- Strain relief with detachable tiwrap plates
- Variable traverse angle for flexible assembly
- The twistability of the E-Chain® and the option to assemble the mounting brackets on the fixed end and/or the moving end, enable various installation options

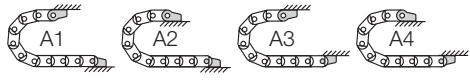

Possible installation conditions for assembled mounting brackets ▶ Order example "preassembled" below

Moving end with bore
(outer link) 3...3PZ(B)

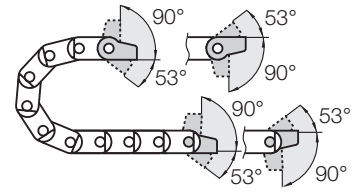

3...4PZ(B) Fixed end
with pin (inner link)

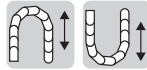

Option polymer - locking

- Recommended for unsupported and gliding applications
- At very high speed and/or acceleration
- If space is limited for height (the H_F measurement)
- The twistability of the E-Chain® and the option to assemble the mounting brackets on the fixed end and/or the moving end, enable various installation options

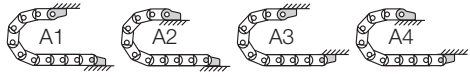

Possible installation conditions for assembled mounting brackets ▶ Order example "preassembled" below

Moving end with bore
(outer link) 3...1PZ(B)

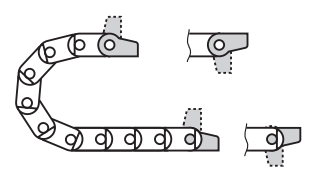

3...2PZ(B) Fixed end
with pin (inner link)

Dimensions and order configurations

Strain relief is possible on the moving end and/or the fixed end.

Part No. structure (pivoting)

3075. 34 PZB A1

A... must be indicated on preassembled configurations
With assembled strain relief tiwrap plates
Full set pivoting = 34
Mounting brackets for selected chain type

Full set, for both ends:

3075. 34 PZB +tiwrap plate

Single-part order:

3075. 3 PZB +tiwrap plate

Mounting bracket with bore

3075. 4 PZB +tiwrap plate

Mounting bracket with pin

Part No. structure (locking)

3075. 12 PZB A1

A... must be indicated on preassembled configurations
With assembled strain relief tiwrap plates
Full set locking = 12
Mounting brackets for selected chain type

Full set, for both ends:

3075. 12 PZB +tiwrap plate

Single-part order:

3075. 1 PZB +tiwrap plate

Mounting bracket with bore

3075. 2 PZB +tiwrap plate

Mounting bracket with pin

3...3PZ(B) Standard! (pivoting)

3...1PZ(B) (locking)

Moving end

Standard! (pivoting) 3...4PZ(B)

(locking) 3...2PZ(B)

Fixed end

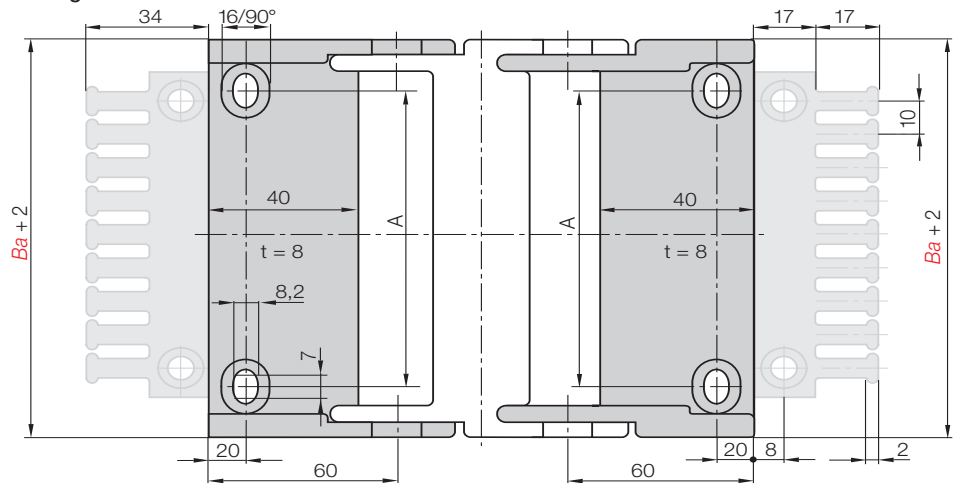

For E-Chain®	Part No. full set with tiwrap plate	Part No. with tiwrap plate + 10 cable tiwraps	Part No. full set without tiwrap plate	Dim. A [mm]
3400 - 3500.050 ▶	3050. <input type="checkbox"/> PZB	3050. <input type="checkbox"/> PZBK1	3050. <input type="checkbox"/> PZ	28
3400 - 3500.075 ▶	3075. <input type="checkbox"/> PZB	3075. <input type="checkbox"/> PZBK1	3075. <input type="checkbox"/> PZ	53
3400 - 3500.100 ▶	3100. <input type="checkbox"/> PZB	3100. <input type="checkbox"/> PZBK1	3100. <input type="checkbox"/> PZ	78
3400 - 3500.115 ▶	3115. <input type="checkbox"/> PZB	3115. <input type="checkbox"/> PZBK1	3115. <input type="checkbox"/> PZ	93
3400 - 3500.125 ▶	3125. <input type="checkbox"/> PZB	3125. <input type="checkbox"/> PZBK1	3125. <input type="checkbox"/> PZ	103
3400 - 3500.150 ▶	3150. <input type="checkbox"/> PZB	3150. <input type="checkbox"/> PZBK1	3150. <input type="checkbox"/> PZ	128
3400 - 3500.175 ▶	3175. <input type="checkbox"/> PZB	3175. <input type="checkbox"/> PZBK1	3175. <input type="checkbox"/> PZ	153
3400 - 3500.200 ▶	3200. <input type="checkbox"/> PZB	3200. <input type="checkbox"/> PZBK1	3200. <input type="checkbox"/> PZ	178
3400 - 3500.225 ▶	3225. <input type="checkbox"/> PZB	3225. <input type="checkbox"/> PZBK1	3225. <input type="checkbox"/> PZ	203
3400 - 3500.250 ▶	3250. <input type="checkbox"/> PZB	3250. <input type="checkbox"/> PZBK1	3250. <input type="checkbox"/> PZ	228

Please add the Part No. with the requested index - 34 for the pivoting configuration

e.g. 3075. 34 PZB or 12 for the locking configuration e.g. 3075. 12 PZB

For the preassembled mode please add the index A1...A4 e.g. 3075. 34 PZB A1



Steel mounting bracket - pivoting

- Pivoting connections
- One part for all chain widths
- Electrically conductive
- Bolted connection outside of chain cross-section possible

Moving end with bore
(outer link) 3000.1

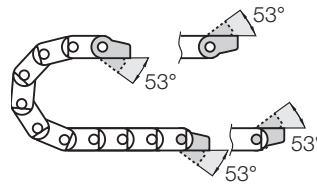

3000.2 Fixed end
with pin (inner link)

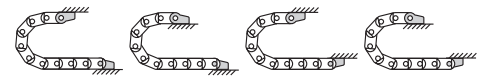

Possible installation conditions -
Further installation angles ► installation sketch

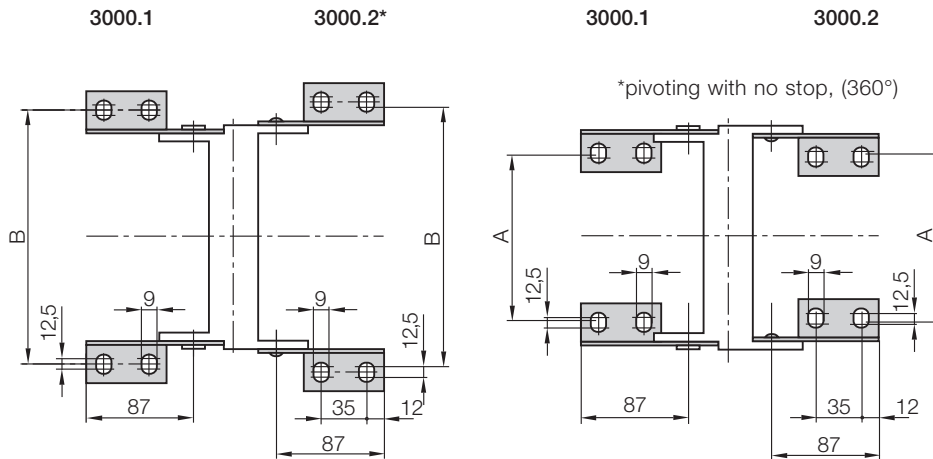

Dimensions and order configurations

For E-Chain®	Part No. full set	Dim. A [mm]	Dim. B [mm]	Dim. C [mm]
3400 - 3500.050 ►	3000.12	28	86	97
3400 - 3500.075 ►	3000.12	53	111	122
3400 - 3500.100 ►	3000.12	78	136	147
3400 - 3500.115 ►	3000.12	93	151	162
3400 - 3500.125 ►	3000.12	103	161	172
3400 - 3500.150 ►	3000.12	128	186	197
3400 - 3500.175 ►	3000.12	153	212	224
3400 - 3500.200 ►	3000.12	178	236	247
3400 - 3500.225 ►	3000.12	203	261	272
3400 - 3500.250 ►	3000.12	228	286	297

3000.12 Full set, 4 parts
2 with pin / 2 with bore

Single-part order:

3000.1 Mounting bracket with bore, 1 part left / right

3000.2 Mounting bracket with pin, 1 part left / right

Phone +49- (0) 22 03-96 49-800
Fax +49- (0) 22 03-96 49-222



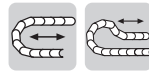

KMA = Polymer Metal Mounting Bracket

Option KMA, pivoting for E-Chains® Series 3400 and Series 3500

- Recommended for unsupported applications
- Bolted connection outside of chain cross-section
- Confined installation conditions
- Universal mountable with attachment capability on all sides
- Stackable

Moving end with bore

Series 3400 = 34001...1

Series 3500 = 34001...1

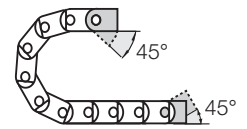

Series 3400 = 34001...2

Series 3400 = 34001...2

Fixed end with pin

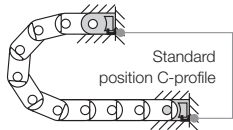

The attachment variants arising automatically by the choice of the KMA mounting bracket

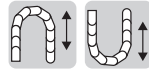

KMA = Polymer Metal Mounting Bracket

Option KMA, locking for E-Chains® Series 3400 and Series 3500

- Recommended for vertical hanging / standing applications
- Bolted connection outside of chain cross-section
- At very high speed and acceleration
- Universal mountable with attachment capability on all sides
- Stackable

Moving end with bore

Series 3400 = 34101...1

Series 3500 = 34101...1

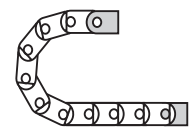

Series 3400 = 34101...2

Series 3500 = 34101...2

Fixed end with pin

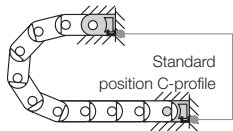

The attachment variants arising automatically by the choice of the KMA mounting bracket

Dimensions and order configurations

Part No. structure (pivoting)

34001.050.12.C A

- A... must be indicated on preassembled configurations
- Integrierted C-profile
- Full set
- Breiten-Index
- KMA pivoting for the selected E-Chain® type

Full set, for both ends:

34001.050.12.C (with C-profile)

Single-part order:

34001.050.1.C (with C-profile)

Mounting bracket **with bore**

34001.050.2.C (with C-profile)

Mounting bracket **with pin**

Part No. structure (locking)

34101.050.12.C A

- A... must be indicated on preassembled configurations
- Integrierted C-profile
- Full set
- Breiten-Index
- KMA locking for the selected E-Chain® type

Full set, for both ends:

34101.050.12.C (with C-profile)

Single-part order:

34101.050.1.C (with C-profile)

Mounting bracket **with bore**

34101.050.2.C (with C-profile)

Mounting bracket **with pin**

3400 | 3500 = 34001...1 (pivoting)

3400 | 3500 = 34101...1 (locking)

3400 | 3500 = 34001...2 (pivoting)

3400 | 3500 = 34101...2 (locking)

Moving end

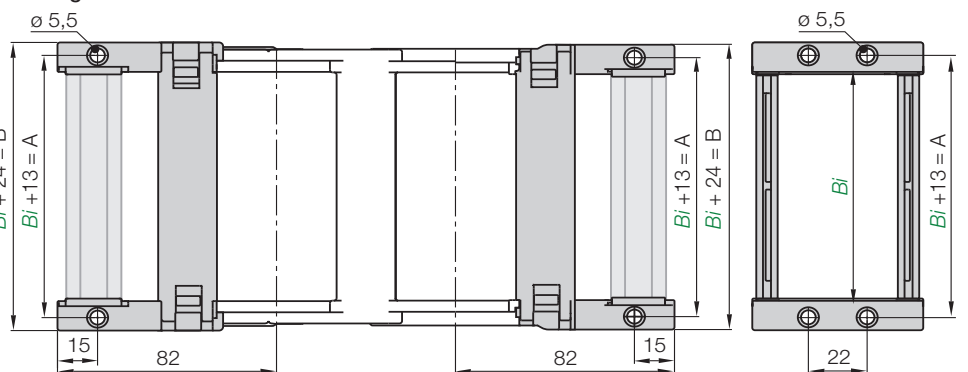

Fixed end

For E-Chain®	Part No. full set	Part No. full set	Dim. A [mm]	Dim B [mm]
Series 3400/3500	with C-profile	without C-profile		
3400/3500.050	050.12.C	050.12	63	74
3400/3500.075	075.12.C	075.12	88	99
3400/3500.100	100.12.C	100.12	113	124
3400/3500.115	115.12.C	115.12	128	139
3400/3500.125	125.12.C	125.12	138	149
3400/3500.150	150.12.C	150.12	163	174
3400/3500.175	175.12.C	175.12	188	199
3400/3500.200	200.12.C	200.12	213	224
3400/3500.225	225.12.C	225.12	238	249
3400/3500.250	250.12.C	250.12	263	274

● For **E-Chains®** please add the Part No. with the requested index

For the pivoting option e.g. 34001.050.12 or for the locking option e.g. 34101.050.12

For the **preassembled** mode please add the index **A** e.g. 34101.050.12 A

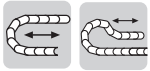

KMA = Polymer Metal Mounting Bracket

Option KMA, pivoting for half E-Tubes Series 3450 and for full E-Tubes Series 3480

- Recommended for unsupported applications
- Bolted connection outside of chain cross-section
- Confined installation conditions
- Universal mountable with attachment capability on all sides
- Stackable

Moving end with bore

Series 3450 = 34500...1

Series 3480 = 34800...1

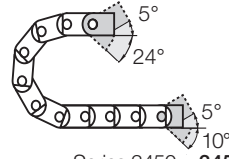

Series 3450 = 34500...2

Series 3480 = 34800...2

Fixed end with pin



The attachment variants arising automatically by the choice of the KMA mounting bracket

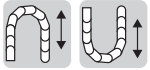
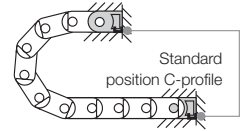

KMA = Polymer Metal Mounting Bracket

**Option KMA, locking for half E-Tubes Series 3450
Option KMA, locking for full E-Tubes Series 3480**

- Recommended for vertical hanging / standing applications
- Bolted connection outside of chain cross-section
- At very high speed and acceleration
- Universal mountable with attachment capability on all sides
- Stackable

Moving end with bore

Series 3450 = 34510...1

Series 3480 = 34810...1

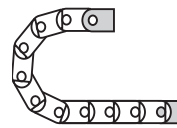

Series 3450 = 34510...2

Series 3480 = 34810...2

Fixed end with pin



The attachment variants arising automatically by the choice of the KMA mounting bracket

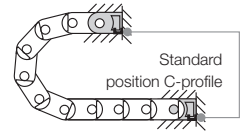

3450 = 34500...1 | 3480 = 34800...1 (pivoting)

3450 = 34500...2 | 3480 = 34800...2 (pivoting)

3450 = 34510...1 | 3480 = 34810...1 (locking)

3450 = 34510...2 | 3480 = 34810...2 (locking)

Moving end

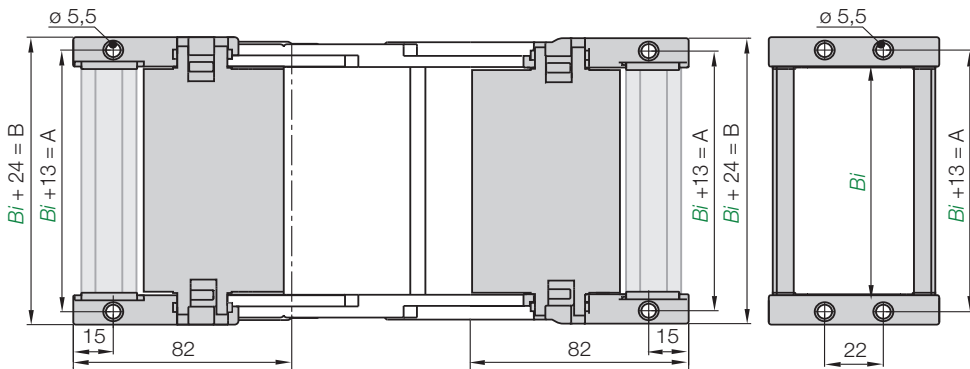

For E-Chain®	Part No. full set	Part No. full set	Dim. A [mm]	Dim B [mm]
Series 3450/3480	with C-profile	without C-profile		
3450/3480.050	...050.12.C	...050.12	63	74
3450/3480.075	...075.12.C	...075.12	88	99
3450/3480.100	...100.12.C	...100.12	113	124
3450/3480.115	...115.12.C	...115.12	128	139
3450/3480.125	...125.12.C	...125.12	138	149
3450/3480.150	...150.12.C	...150.12	163	174
3450/3480.175	...175.12.C	...175.12	188	199
3450/3480.200	...200.12.C	...200.12	213	224
3450/3450.225	...225.12.C	...225.12	238	249
3450/3450.250	...250.12.C	...250.12	263	274

- For **half E-Tube** please add the Part No. with the requested index
For the pivoting option e.g. **34500**.075.12 or for the locking option e.g. **34510**.075.12
For the **preassembled** mode please add the index **A** e.g. **34510**.075.12**A**
- For **full E-Tube** please add the Part No. with the requested index
For the pivoting option e.g. **34800**.075.12 or for the locking option e.g. **34810**.075.12
For the **preassembled** mode please add the index **A** e.g. **34810**.075.12**A**

Dimensions and order configurations

Part No. structure (pivoting)

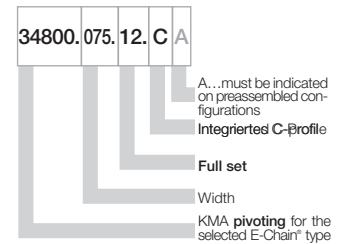

Full set, for both ends:

34800.075.12.C (with C-profile)

Single-part order:

34800.075.1. C (with C-profile)

Mounting bracket with bore

34800.075.2. C (with C-profile)

Mounting bracket with pin

Part No. structure (locking)

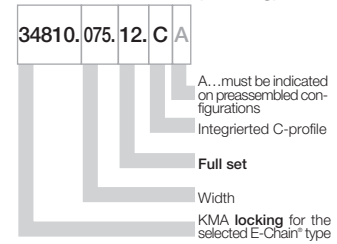

Full set, for both ends:

34810.075.12.C (with C-profile)

Single-part order:

34810.075.1. C (with C-profile)

Mounting bracket with bore

34810.075.2. C (with C-profile)

Mounting bracket with pin

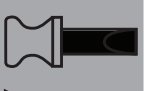



Tiewrap plate as individual part

As individual component screwed on KMA. Can be plugged in the mounting brackets. **Details ▶ chapter 10**

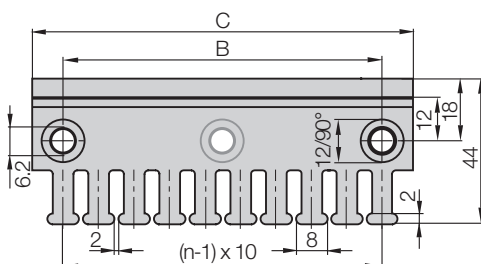
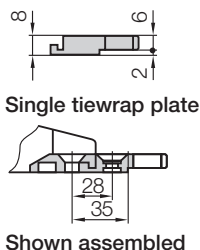

Tiewrap plate	No. of teeth <i>n</i>	Dim. C [mm]	Dim. B [mm]
3050.ZB	5	50	30
3075.ZB	7	75	55
3100.ZB	10	100	80
3115.ZB	11	115	95
3125.ZB	12	125	105
3150.ZB	15	150	130
3175.ZB	17	175	155
3200.ZB	20	200	180
3225.ZB	22	225	205
3250.ZB	25	250	230

(- = no / + = yes)



Cable tie-wraps as individual part

Cable tie-wraps (100-piece bag)	Width x length	max. Ø	Tensile strength
CFB.001	4,8 x 150 mm	36 mm	222 N



"Double" strain relief

If an E-Chain® is harnessed with a very large number of cables, strain relief may be necessary at two levels. Our 30XX.Z and 30XX.ZS strain relief system was developed for this purpose. It can be placed in any position along the E-Chain®. As required, the 30XX.Z and 30XX.ZS strain relief system is simply clamped onto the crossbar of the chain link. No additional installation elements are needed. **Details ▶ chapter 10**

Art. Nr. crossbar (fixed)	Width [mm]	No. of teeth
3050.Z*	50	5
3075.Z*	74	7

Art. Nr. crossbar (openable)	Width [mm]	No. of teeth
3035.ZS**	35	3
3050.ZS**	50	5
3075.ZS**	75	7

*not available for Series 3450 and 3480 **not available for Series 3480

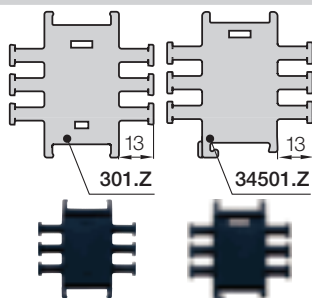

Strain relief separator

Separator with integrated strain relief, for use in the first or last chain link. For manufacturing of switchgear cabinets or for the assembly of machines. Easy to assemble without any fastening device. Separator base 2020.Z is 18 mm and 34501.Z is 14 mm wide. The possible number of separators per E-Chain® is defined by its inner width *Bi* and by the cable-diameter. **Details ▶ chapter 10**

Part No.	Number of teeth	For Series
301.Z	3 both sides	3400/3500 E-Chain®
34501.Z	3 both sides	3450/3480 E-Tube



Strain relief for steel mounting brackets

Clip-on connection is not possible with steel mounting brackets. In this case, the tie-wrap plates must be bolted directly into separate bore holes in front of the mounting bracket. Alternatively the tie-wrap plates 30XX.Z and ZS can be also used here. **Details ▶ chapter 10**

Chainfix strain relief C-profile-solutions - more Details ▶ chapter 10



Other strain relief elements - optional ▶ chapter 10



Chainfix clamps made of steel or stainless steel



Chainfix Clips - modular, snap-on



Chainfix Nugget with pre-harnessed cable strap



Chainfix - tie-wrap plates with clip-on connection

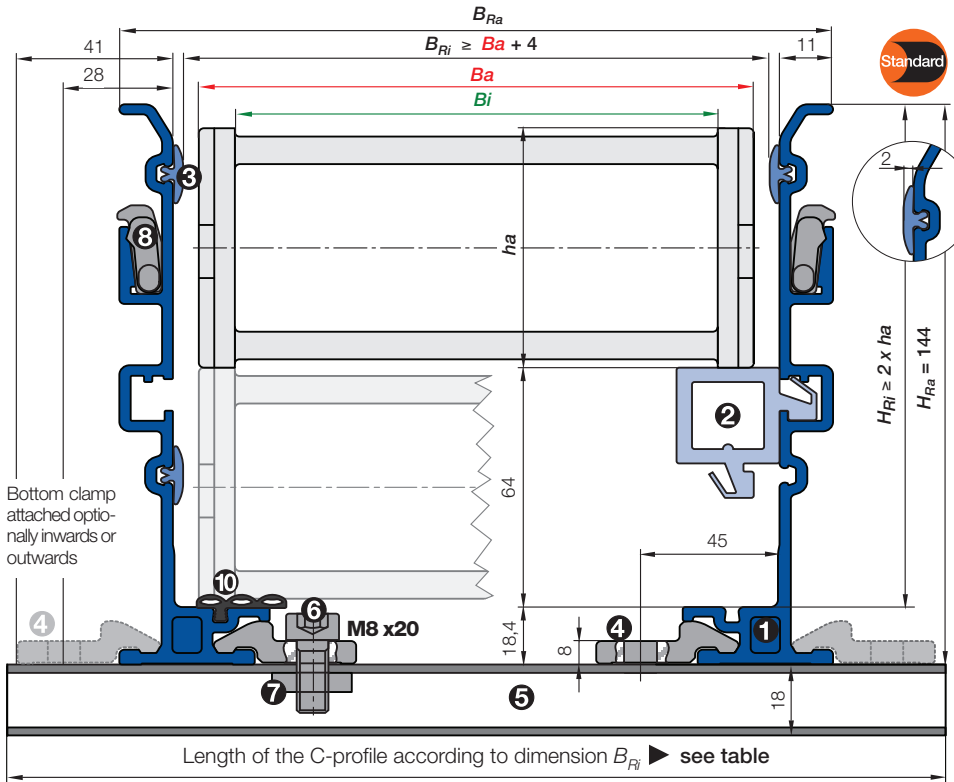

- B_a = Outer width E-Chains® / E-Tube
- B_i = Inner width E-Chains® / E-Tube
- h_a = Outer height E-Chains® / E-Tube
- H_{Ri} = Inner trough height
- H_{Ra} = Outer trough height
- B_{Ri} = Inner trough width ▶ depends on dim. B_a
- B_{Ra} = Outer trough width
- n_{Mon} = Number of installation sets (left/right)
- n_{Ri} = Number of trough sets (left/right)
- ! $H_{Ri} \geq 2 \cdot h_a$
- ! $B_{Ri} \geq B_a + 4$
- = Guide trough set ● = Glide bar
- = Installation set "Basic" ● = C-Profile

Installation set "Basic" with C-Profile

Bottom Clamp attached optionally inwards or outwards

3500.075.200.0 ▶ Order example

	Part No.	Part No.
B_{Ri} [mm]	attached inwards	attached outwards
.050	74	960.40.200
.075	99	960.40.225
.100	124	960.40.175 960.40.250
.115	139	960.40.200 960.40.275
.125	149	960.40.200 960.40.275
.150	174	960.40.225 960.40.300
.175	199	960.40.250 960.40.325
.200	224	960.40.275 960.40.350
.225	249	960.40.300 960.40.375
.250	274	960.40.325 960.40.400



- **Components, trough "Basic":** ① Trough side parts, aluminum, 2 m ② Glide bar, plastic, 2 m ③ Glide strips, plastic, 2 m (without glide strips on request) ⑩ Optional: Silencer profile, rubber
- **Components, installation set "Basic":** ④ Bottom clamp, aluminum ⑤ C-profile, steel galvanized ⑥ Screw M6 x16 ⑦ Sliding nut M6 ⑧ Interface connector, plastic

Order example: Length of travel 30 m - Center mounted for Series 3500.100.200.0 with $B_{Ri} = 124$

- Guide trough set (set of 2 trough side parts, incl. glide strips) **without** glide bar
Order text: 16 m guide trough without glide bar (8 x 2 m sections) Part No. 973.30.SL
- Guide trough set (set of 2 trough side parts, incl. glide strips) **with** glide bar
Order text: 16 m guide trough with glide bar (8 x 2 m sections) Part No. 973.31.SL
- Installation set "Basic" complete (guide trough-sets + 1)
Order text: 17 installation sets "Basic" Part No. 960.40.175
- Module for the fixed end
Order text: 1 set Part No. 973.80
- Option:** For an additional noise dampening with silencer profile, please add Index A - Example:
Part No. 973.30.SLA

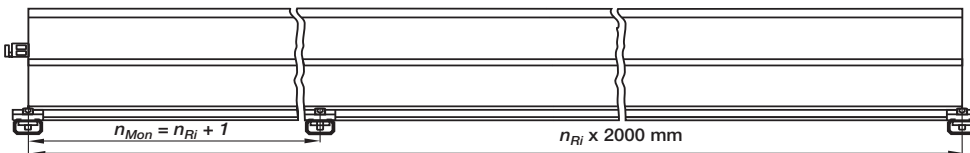

Principle sketch: Number of installation sets to be installed = **Number of trough sections + 1**

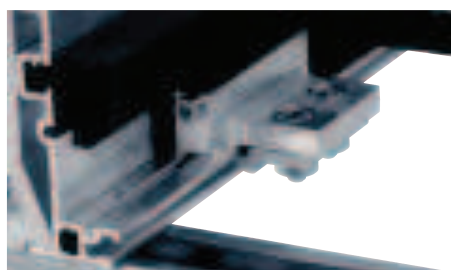

A quick fix for mounting the stationary end of an E-Chain®
 With this module for the fixed end, fast and easy mounting onto the Aluminum "SuperTrough" is now possible without any drilling. Fast mounting of the E-Chain® by clamping onto the aluminum trough

- Quick relocation of the stationary end
- No drilling necessary

Insert for the installation set "Heavy-Duty": **973.50.XXX** instead of **(960.40.XXX)** on the right column "attached outwards"

Phone +49- (0) 22 03-96 49-800
 Fax +49- (0) 22 03-96 49-222

