

Price index



Side-mounted - unsupported



ESD classification:  
Electrically conductive ESD/ATEX version upon request



High torsional rigidity



Opening E-Chains®: Remove crossbars and clips - Insert screwdriver into the slot, push down, release by lever action



Remove lids/bottoms (E-Tubes) - Insert screwdriver into the slot, release by lever action



When to use the Series 5050/5150/R9850:

- When high torsional forces are expected
- For side-mounted applications involving large unsupported lengths
- Due to very dirt and dusty environment
- Also available as Rol E-Chain®



When not to use it:

- When very long travels or high additional loads are involved
  - ▶ Series 5050HD, page 7.268
- If a simple and low-cost solution is required
  - ▶ Series 15050/R19850, page 7.144

- 1 High side-mount stability due to undercut
  - 2 High torsional rigidity
  - 3 Closed and open styles can be combined
  - 4 Hinged snap-open removable lids of E-Tube
  - 5 Numerous interior separation possibilities
  - 6 Crossbars on E-Chains® are removable along both radii
  - 7 Lateral glide surfaces for side-mounted operation
  - 8 Wide, rounded plastic crossbars - cable friendly
  - 9 KMA mounting brackets with attachment points on all sides
  - 10 Mounting brackets with integrated strain relief available, locking or pivoting
  - 11 E-Chains® also available with reverse bending radius "RBR"
- ! "Heavy-Duty" size available. Greater unsupported length for higher loads and travels. Also available as Rol E-Chain® version



Rol E-Chain® Series 5050R/9850R available upon request

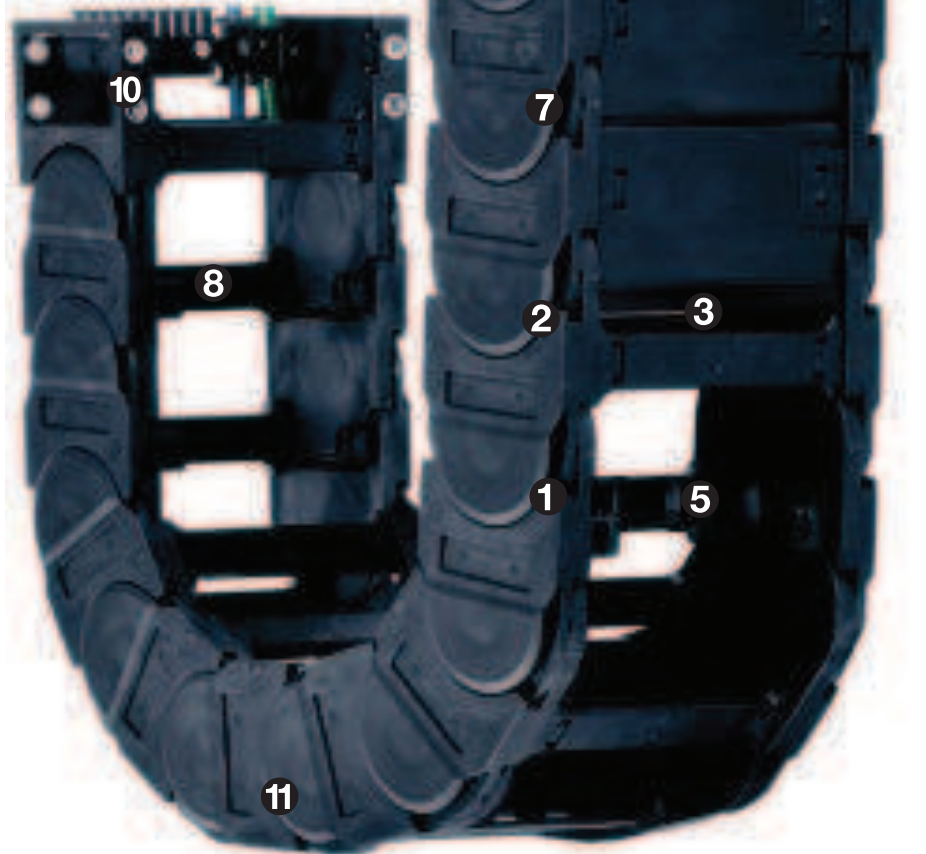

Order example complete E-Chain®

Please indicate chain-lengths or number of links Example: 5 m or 55 links

5 m 5050.30.300.0



E-Chain®

with 2 separators 511 assembled every 2<sup>nd</sup> link



Interior separation

1 set 50500.30.12C



Mounting bracket



### Unsupported length

$FL_G$  = with straight upper run

$FL_B$  = with permitted sag

Further information ► Design, page 1.12

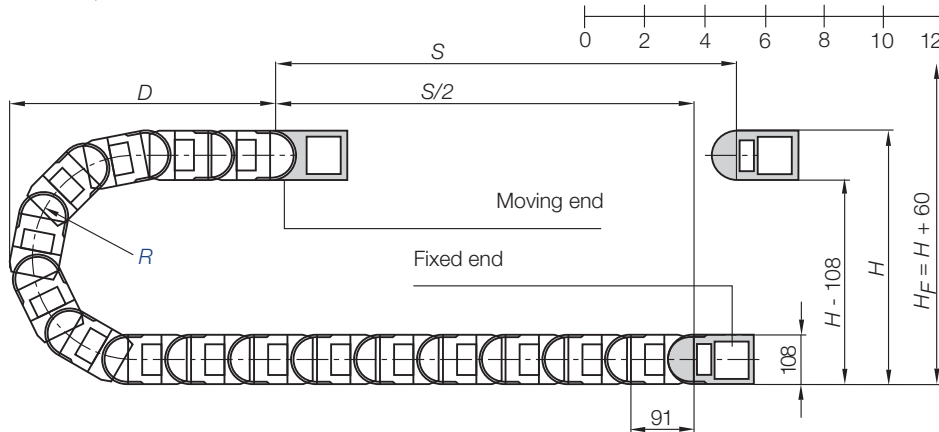
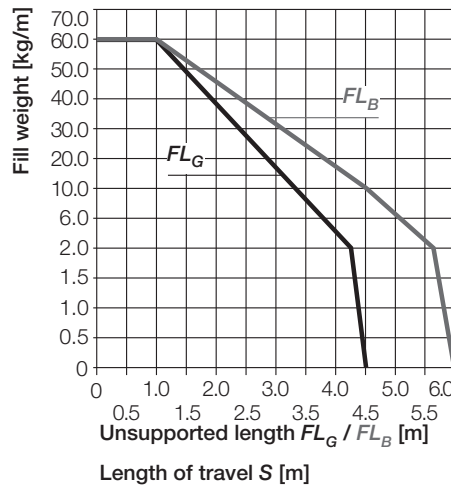
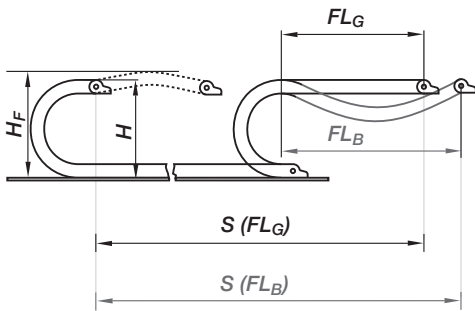

Pitch = 91 mm/link    Links/m = 11 (1001 mm)    Chain length =  $S/2 + K$

R	150	200	250	300	350	400	500	550	600	650	1000
$H_{-0}^{+25}$	408	508	608	708	808	908	1108	1208	1308	1408	2108
D	295	345	395	445	495	545	645	695	745	795	1145
K	655	815	970	1125	1285	1440	1755	1910	2070	2225	3255
$H_2$	242	242	242	242	242	242	242	242	242	-	-
$D_2^{+25}$	550	800	950	1200	1550	1700	2175	2355	2580	-	-
$K_2$	910	1274	1638	2002	2457	2730	3458	3640	4459	-	-

- S = Length of travel
  - R = Bending radius
  - H = Nominal clearance height
  - $H_F$  = Required clearance height
  - $H_{RI}$  = Trough inner height
  - D = Overlength E-Chain® radius in final position
  - $K = \pi \cdot R + \text{"safety"}$
  - $D_2$  = Over length - long travels, gliding
  - $K_2$  = \*Further add-on
  - $H_2$  = \*Mounting height
- \*if the mounting bracket location is set lower

#### Other installation methods

- Vertical, hanging  $\leq 120$  m
- Vertical, standing  $\leq 6$  m
- Side mounted, un supp.  $\leq 3$  m
- Rotary requires further calculation
- Unsupported length of upper run = upon request



#### Short travels - unsupported

Unsupported E-Chains® feature positive camber over short travels. This must be accounted for when specifying the clearance height  $H_F$ . Please consult igus® if space is particularly restricted.

The required clearance height:  
 $H_F = H + 60$  mm  
(with 3,0 kg/m fill weight)

Long travel lengths from 10 m to max. 400 m    Chain length =  $S/2 + K_2$

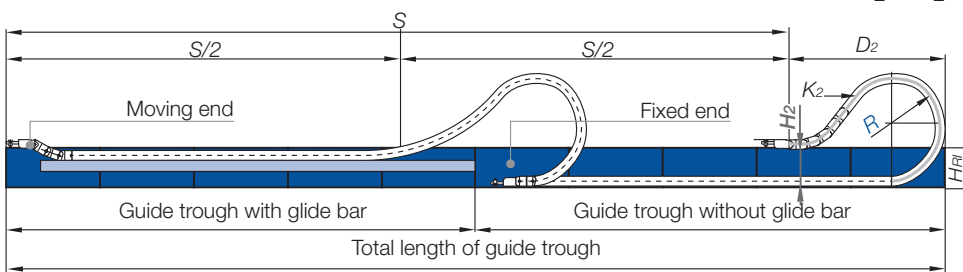

In case of travels between 4 and 10 m we recommend a longer unsupported length.



#### Gliding, long travel applications (max. 400 m)

In this case the E-Chain® upper run will be introduced in a guide trough on the lower run. We recommend to realize the engineering of such a plant by our technicians.

Speed / acceleration $FL_G$	max. 20 [m/s] / max. 200 [m/s <sup>2</sup> ]
Speed / acceleration $FL_B$	max. 3 [m/s] / max. 6 [m/s <sup>2</sup> ]
Gliding speed / acceleration (maximum)	max. 10 [m/s] / max. 50 [m/s <sup>2</sup> ]
Material - permitted temperature °C	igumid G / -40° up to +120° C
Flammability class, igumid G	VDE 0304 IIC UL94 HB

#### Technical Data



Details of material properties  
► page 1.38

For support of the lower run - Support Tray tool kit available ► page 9.70



System E4/4  
Inner height: 80 mm

Phone +49- (0) 22 03-96 49-800  
Fax +49- (0) 22 03-96 49-222

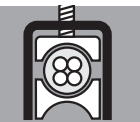

► page 7.223

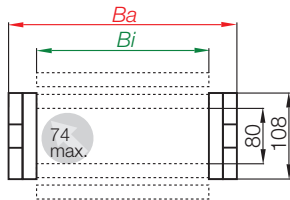

Part No. structure

5050. 30. 300. 0



Series 5050 - E-Chain® with crossbars every link

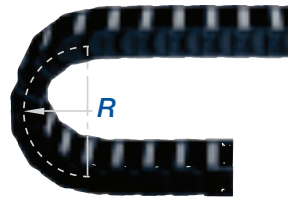

- Crossbars every link
- For rigid hydraulic hoses
- For applications particularly demanding
- Can be opened from two sides

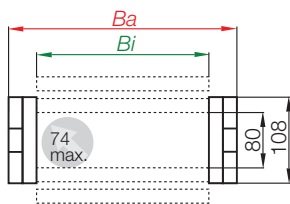

Part No. structure

5150. 30. 300. 0



Series 5150 - E-Chain® with crossbars every 2<sup>nd</sup> link

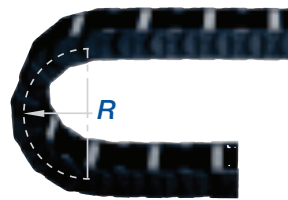

- Crossbars every 2<sup>nd</sup> link = Standard
- For nearly every situation
- Can be opened from two sides
- Easy assembly
- Stable
- Attractive price

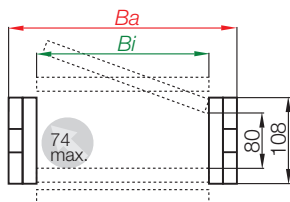

Part No. structure

9850. 30. 300. 0



Series R9850 - Fully enclosed E-Tube

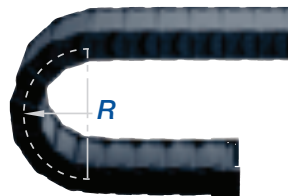

- Fully enclosed
- Excellent cable protection against dirt
- Protection against hot chips (up to 900°C)
- Lids along the entire inner radius are completely removable. Lids along the entire outer radius are single sided snap-open with a hinge on the other side to keep them attached to the chain or completely removable.



**Rol instead of gliding: Rol E-Chain®**

Special solution for long travels. 75% less drive power (gliding application) with igus® Rol E-Chain®.  
Series 5050R and 9850R - Order example 5050R.30.300.0  
Further information: [www.igus.de/en/role](http://www.igus.de/en/role)  
or phone: +49-0 22 03-96 49-800



Part No.		<i>Bi</i> [mm]	<i>Ba</i> [mm]	5050 [kg/m]	5150 [kg/m]	R9850 [kg/m]
5050/5150.05.	<input type="checkbox"/> .0	50	100	≈ 5,63	≈ 5,62	-
5050/5150.06.	<input type="checkbox"/> .0	65	115	≈ 5,70	≈ 5,68	-
5050/5150/9850.07.	<input type="checkbox"/> .0	75	125	≈ 5,79	≈ 5,70	≈ 6,24
5050/5150.08.	<input type="checkbox"/> .0	87	137	≈ 5,89	≈ 5,76	-
5050/5150/9850.10.	<input type="checkbox"/> .0	100	150	≈ 5,96	≈ 5,79	≈ 6,52
5050/5150.11.	<input type="checkbox"/> .0	112	163	≈ 6,09	≈ 5,85	-
5050/5150/9850.12.	<input type="checkbox"/> .0	125	175	≈ 6,16	≈ 5,89	≈ 6,89
5050/5150.13.	<input type="checkbox"/> .0	137	188	≈ 6,29	≈ 5,95	-
5050/5150/9850.15.	<input type="checkbox"/> .0	150	200	≈ 6,36	≈ 5,98	≈ 7,32
5050/5150.16.	<input type="checkbox"/> .0	162	213	≈ 6,47	≈ 6,04	-
5050/5150.17.	<input type="checkbox"/> .0	175	225	≈ 6,58	≈ 6,09	-
5050/5150.18.	<input type="checkbox"/> .0	187	238	≈ 6,69	≈ 6,15	-
5050/5150/9850.20.	<input type="checkbox"/> .0	200	250	≈ 6,71	≈ 6,16	≈ 7,89
5050/5150.21.	<input type="checkbox"/> .0	212	263	≈ 6,82	≈ 6,22	-
5050/5150.22.	<input type="checkbox"/> .0	225	275	≈ 6,89	≈ 6,25	-
5050/5150.23.	<input type="checkbox"/> .0	237	288	≈ 7,02	≈ 6,31	-
5050/5150/9850.25.	<input type="checkbox"/> .0	250	300	≈ 7,11	≈ 6,36	≈ 8,61
5050/5150.26.	<input type="checkbox"/> .0	262	313	≈ 7,19	≈ 6,40	-
5050/5150/9850.27.	<input type="checkbox"/> .0	275	325	≈ 7,30	≈ 6,46	≈ 8,82
5050/5150.28.	<input type="checkbox"/> .0	287	338	≈ 7,33	≈ 6,47	-
5050/5150/9850.30.	<input type="checkbox"/> .0	300	350	≈ 7,55	≈ 6,58	≈ 9,27
5050/5150.31.	<input type="checkbox"/> .0	312	363	≈ 7,58	≈ 6,60	-
5050/5150.32.	<input type="checkbox"/> .0	325	375	≈ 7,63	≈ 6,62	-
5050/5150.33.	<input type="checkbox"/> .0	337	388	≈ 7,81	≈ 6,71	-
5050/5150/9850.35.	<input type="checkbox"/> .0	350	400	≈ 7,96	≈ 6,79	≈ 10,02
5050/5150.36.	<input type="checkbox"/> .0	362	413	≈ 7,97	≈ 6,80	-
5050/5150.37.	<input type="checkbox"/> .0	375	425	≈ 7,99	≈ 6,80	-
5050/5150.38.	<input type="checkbox"/> .0	387	438	≈ 8,07	≈ 6,84	-
5050/5150/9850.40.	<input type="checkbox"/> .0	400	450	≈ 8,27	≈ 6,94	≈ 10,98
5050/5150.41.	<input type="checkbox"/> .0	412	463	≈ 8,43	≈ 7,02	-
5050/5150.42.	<input type="checkbox"/> .0	425	475	≈ 8,58	≈ 7,10	-
5050/5150.43.	<input type="checkbox"/> .0	437	488	≈ 8,65	≈ 7,13	-
5050/5150.45.	<input type="checkbox"/> .0	450	500	≈ 8,71	≈ 7,16	-
5050/5150/9850.46.	<input type="checkbox"/> .0	462	513	≈ 8,73	≈ 7,17	≈ 11,44
5050/5150.47.	<input type="checkbox"/> .0	475	525	≈ 8,87	≈ 7,24	-
5050/5150.48.	<input type="checkbox"/> .0	487	538	≈ 8,88	≈ 7,26	-
5050/5150.50.	<input type="checkbox"/> .0	500	550	≈ 9,00	≈ 7,30	-
5050/5150.51.	<input type="checkbox"/> .0	512	563	≈ 9,02	≈ 7,32	-
5050/5150.52.	<input type="checkbox"/> .0	525	575	≈ 9,06	≈ 7,34	-
5050/5150.53.	<input type="checkbox"/> .0	537	588	≈ 9,22	≈ 7,41	-
5050/5150.55.	<input type="checkbox"/> .0	550	600	≈ 9,70	≈ 7,66	-
5050/5150.60.	<input type="checkbox"/> .0	600	650	≈ 9,90	≈ 7,76	-

Available bending radii

R [mm] 150\* 200 250 300 350 400 500 550 600 650 1000

Supplement Part No. with required radius. Example: 5050.30.300.0

0 = standard color, other colors ▶ page 1.39 · Pitch = 91 mm/link - Links/m = 11

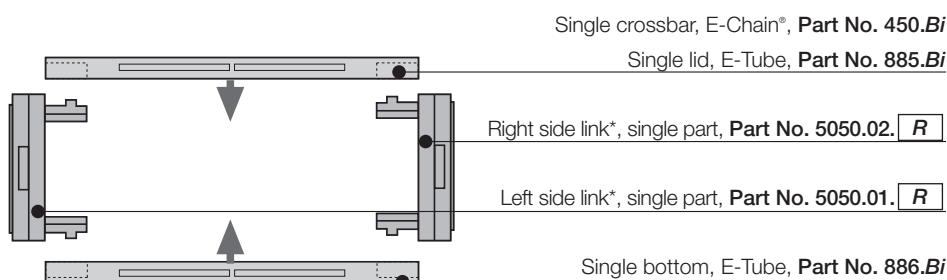

## Hot Chips up to 850°C

E-Tubes that repel hot chips, up to 850°C. Some applications, depending on amount and size of the chips, can burn or melt the surface. That is no longer the case with the igus® "igumid HT" material. Order example:

Full E-Tube made of HT\*:  
**9850.40.250.0.HT**  
 Lids made of HT:  
**9850.40.HTE.250.0**

\*for long travels upon request  
 Further Information:  
[www.igus.de/en/HT](http://www.igus.de/en/HT)  
**Delivery time**  
 up to 4 weeks!

## Extreme Glider...

...with up to 70% larger glide surface. For high additional loads and high gliding speeds. Gliding applications without additional elements as well as 150% more wear allowance and improvement of service life by factor 4!

Order example:  
**5050.35G.250.0**  
**5050.45G.250.0**  
 Further information:  
 phone +49-0 22 03-96 49-800

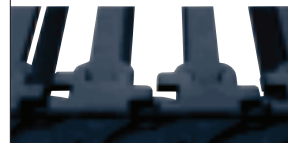

\*not available for R9850



Extender crossbar for large diameter hoses ▶ page 7.274

## Part No. E-Chain® - links, single parts

\*View from the fixed point of the E-Chain®/E-Tube

System E4/4  
 Inner height: 80 mm

Phone +49- (0) 22 03-96 49-800  
 Fax +49- (0) 22 03-96 49-222

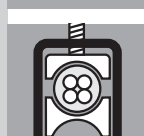
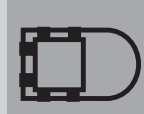

▶ page 7.223



Vertical separators are used if a vertical subdivision is required. In the standard configuration, a separator is mounted at every second link. **Note:** Observe a lateral spacing of at least 33 mm (E-Tube) and 16 mm (E-Chain)!

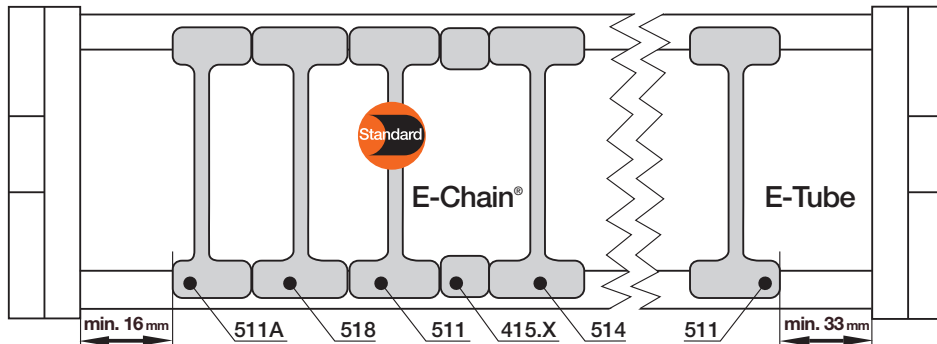

Vertical separator  
501



Spacer  
405.XX



Locking separator  
504



Locking separator  
508



Asymmetric  
separator 501A

Vertical separator for E-Chains®	
unassembled	501
assembled	511

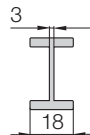

Spacer* for E-Chains®	
unassembled	405.XX
assembled	415.XX



Locking separator for E-Chains®	
unassembled	504
assembled	514

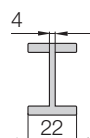

Locking separator for E-Chains®	
unassembled	508
assembled	518

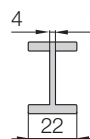

Asymmetric separator for E-Chains®	
unassembled	501A
assembled	511A

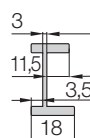

\*For side-mounted applications

### Option 1: Vertical separators and spacers

● **Standard separator 501 for E-Chains®** offers safe stability due to its broad foot design, also when used with thick cables or hoses.

● Separators (e.g. "side mounted") for E-Chains® can be fixed in their position with **spacers 405.XX**. The available inner height will be reduced by 2 mm, per spacer and side. To avoid this, the parts can be assembled on outside of the crossbar (not for long travels) **XX = width of the spacer** (available 10, 15, 20, 30 and 40 mm)

### Additionally:

● **Locking separator for E-Chains® 504-** with increased retention force for applications exposed to very high humidity or extreme loads. If locking separators are used, the E-Chain® is more difficult to open

● The **locking separator for E-Chains® 508** is designed for applications exposed to extremely high humidity, for example, at composting plants. The lateral cam serves for uniform alignment of the vertical separators; if these separators are misaligned, they will inevitably get damaged on an attempt to open the E-Chain®.

● **Asymmetric separator 501A for E-Chains®** (not for E-Tubes) with an 18-mm base, for combinations between spacers of different widths and vertical separators in side-mounted applications, for instance.

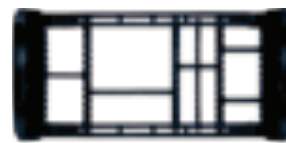
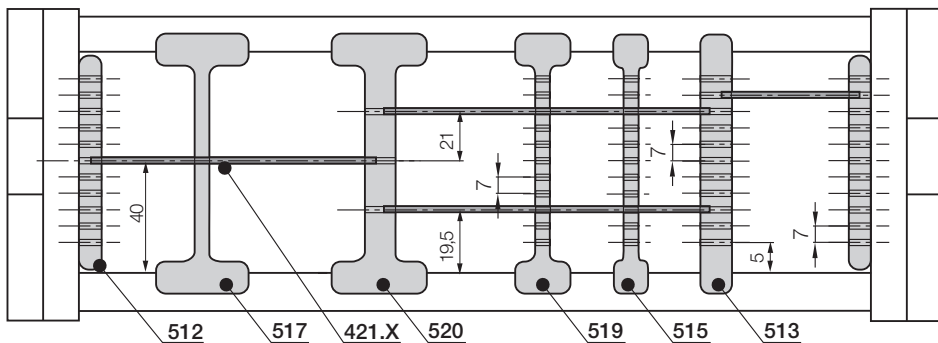

For use with many cables of differing diameters. E-Chains® and E-Tubes can be subdivided both vertically and horizontally. The shelves can be arranged elevator-shifted with different bottoms

### Option 2: Shelves

● **Side plates 502, middle plates 503 and shelves 420.X** form the basic pattern of a shelf system. Shelves of various widths can be arranged at 11 different heights (in 7 mm increments).

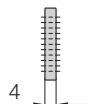

Side plate for E-Chains®/E-Tubes		
unassembled		502
assembled		512

● **Locking vertical separator 510** combined with shelves. Triple slots (only for E-Chains®).

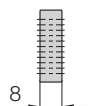

Middle plate for E-Chains®/E-Tubes		
unassembled		503
assembled		513

● **Locking separator 507 slotted** - with increased retention force for applications exposed to very high humidity or extreme loads. The extra retention force is achieved by asymmetric claws for the crossbar. Ensure proper alignment.

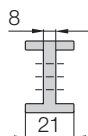

Locking vertical separator for E-Chains®		
unassembled		510
assembled		520

● **Slotted separators 505** are used for very fine subdivisions. However, they cannot be retrofitted into an existing separation system without dismantling the interior separators first.

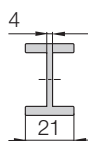

Locking separator for E-Chains®		
unassembled		507
assembled		517

● The unilateral **open slotted separator 509** can be retrofitted into an existing interior separation system without a need for dismantling the interior separators. During an installation of open slotted separators, the top and bottom notches cannot be occupied by shelves.

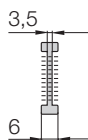

Slotted separator for E-Chains®/E-Tubes		
unassembled		505
assembled		515

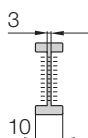

Open slotted separator for E-Chains®/E-Tubes		
unassembled		509
assembled		519



Side plate 502



Middle plate 503



Locking vertical separator 510



Locking separator slotted 507



Slotted separator 505



Open slotted separator 509



Shelf 420.X

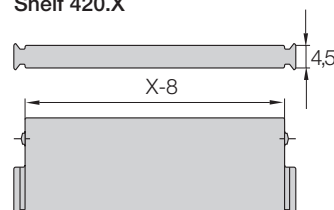

Width X [mm]	Part No. unassembled	Part No. assembled
018	420.18	421.18
023	420.23	421.23
025	420.25	421.25
028	420.28	421.28
033	420.33	421.33
043	420.43	421.43
050	420.50	421.50
062	420.62	421.62

Width X [mm]	Part No. unassembled	Part No. assembled
075	420.75	421.75
088	420.88	421.88
100	420.100	421.100
125	420.125	421.125
150	420.150	421.150
175	420.175	421.175
187	420.187	421.187
200	420.200	421.200

### Additional elements for interior separation

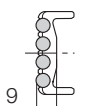

Rollclip		
unassembled		489.27
assembled		490.27

**Rollclip** - minimizes abrasion of particularly sensitive hoses. The Rollclip is simply clamped onto the opening crossbar. The movable rollers compensate for relative movement between the chain and hose.

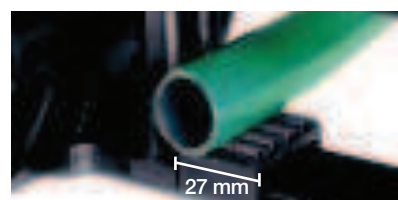

System E4/4  
Inner height: 80 mm

Phone +49- (0) 22 03-96 49-800  
Fax +49- (0) 22 03-96 49-222

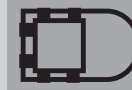

▶ page 7.223

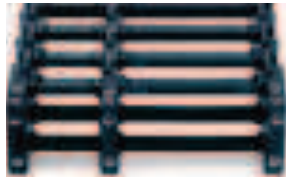

Part No. structure  
5050.10 /20 /10. .0  
5050.Bi1/Bi2/Bi3. .0

### Extension links - for extremely wide E-Chains® up to 3,0 m

- For applications in which particularly high fill weights necessitate extremely wide E-Chains® (up to 3000 mm)
- The extension link design allows virtually limitless side-by-side attachment of chains
- The unsupported length of a chain can be increased when additional loads are required
- Extension links can be used with E-Chains®, E-Tubes or as a combination of both
- They are suitable for unsupported and gliding applications in a guide trough
- E-Chains® with extension links are attached with KMA or steel mounting brackets

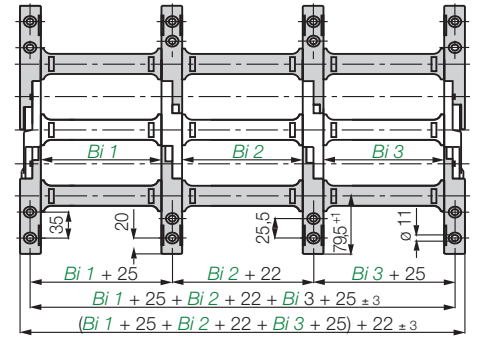
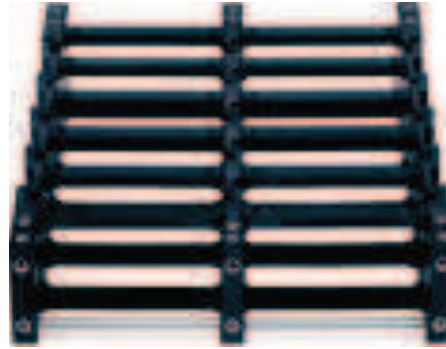

Consult igus® for your extender crossbar applications. We are happy to assist you with your design layout

### Extender crossbars - careful guide of hoses applications

- Suitable for hoses with a maximum outer diameter of 270 mm
- Gliding operation with crossbars assembled along the outer radius and a special guide trough
- Gliding operation not guaranteed with crossbars assembled along the inner radius
- The extender crossbar can either be attached to the side links directly or can be used in combination with two stranded snap-open crossbars

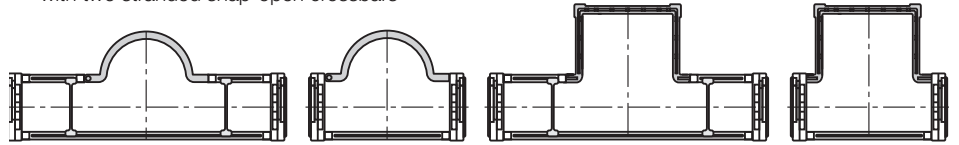

Round extender crossbar with snap-open crossbars    Attached directly to the side link    Square extender crossbar with snap-open crossbars    Attached directly to the side link

Part No.	Max Ø [mm] hose	Form	Installation side link	Combination with snap-open crossb.
450.15.RHD115	115	○	-	+
450.17.RD115	115	○	+	-
450.25.D150	150	□	+	-
450.30.D200	200	□	+	-
450.35.D250	220	□	+	-
450.40.D300	270	□	+	-
450.20.HD150	150	□	-	+
450.25.HD200	200	□	-	+
450.30.HD250	220	□	-	+

○ = round    □ = square    + = yes / - = no



### E4 clip-on cable binder

- For side-mounted applications    ● Serves as a clip-on, lateral guide for hoses and cables on E-Chains®
- The loops can be adjusted as required    ● Compatible with many E4 E-Chains®    ● Stylish and economical
- One clip and one locking band are needed for each chain link    ● Call us if you have any questions on project planning

Part No.	Form
450.B12	Locking clip, comprising a locking element
450.B12.200	Locking band, comprising a locking element and band; 12 x 1,5 x 200 mm

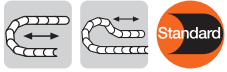

### The Standard - Option KMA\* - pivoting

- Recommended for unsupported and gliding applications
- Confined installation conditions
- Option - integrated C-profile strain relief device with Chainfix clip or strain relief tiwrap plates
- Corrosion resistant
- Universal mountable with attachment capability on all sides

\*KMA = Polymer Metal Mounting Bracket

Moving end  
50500/98500...1

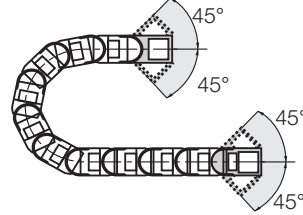

Fixed end  
50500/98500...2



The attachment variants arising automatically by the choice of the KMA mounting bracket

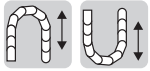
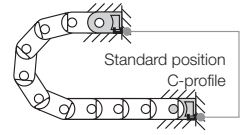

### Option KMA - locking

- Recommended for vertical hanging / standing applications

Additionally:

- Universal mountable
- C-profile option
- Corrosion resistant
- Locked connections
- At very high acceleration

Moving end  
51500/99500...1

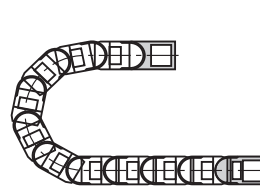

Fixed end  
51500/99500...2



The attachment variants arising automatically by the choice of the KMA mounting bracket

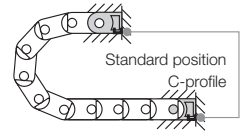

Fixed end  
50500/98500...2 (pivoting)  
51500/99500...2 (locking)

Moving end  
(pivoting) 50500/98500...1  
(locking) 51500/99500...1

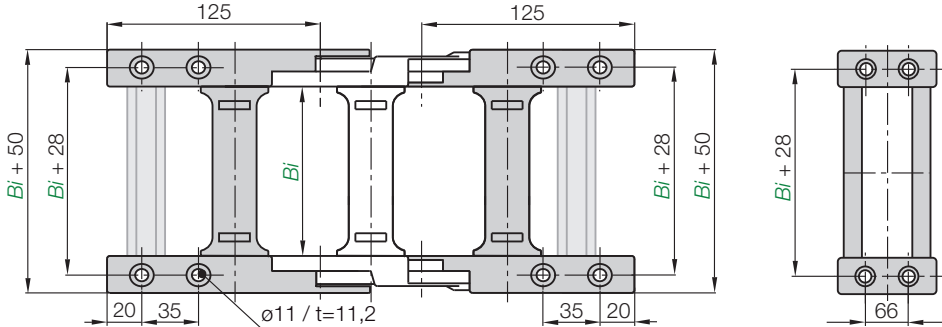

Width index	Part No. full set pivoting	Part No. full set locking	C-profile option [mm]	Bi	Width index	Part No. full set pivoting	Part No. full set locking	C-profile option [mm]	Bi
.05.	50500	51500	.05.12.C	50	.31.	50500	51500	.31.12.C	312
.06.	50500	51500	.06.12.C	65	.32.	50500	51500	.32.12.C	325
.07.	50500/98500	51500/99500	.07.12.C	75	.33.	50500	51500	.33.12.C	337
.08.	50500	51500	.08.12.C	87	.35.	50500/98500	51500/99500	.35.12.C	350
.10.	50500/98500	51500/99500	.10.12.C	100	.36.	50500	51500	.36.12.C	362
.11.	50500	51500	.11.12.C	112	.37.	50500	51500	.37.12.C	375
.12.	50500/98500	51500/99500	.12.12.C	125	.38.	50500	51500	.38.12.C	387
.13.	50500	51500	.13.12.C	137	.40.	50500/98500	51500/99500	.40.12.C	400
.15.	50500/98500	51500/99500	.15.12.C	150	.41.	50500	51500	.41.12.C	412
.16.	50500	51500	.16.12.C	162	.42.	50500	51500	.42.12.C	425
.17.	50500	51500	.17.12.C	175	.43.	50500	51500	.43.12.C	437
.18.	50500	51500	.18.12.C	187	.45.	50500	51500	.45.12.C	450
.20.	50500/98500	51500/99500	.20.12.C	200	.46.	50500/98500	51500/99500	.46.12.C	462
.21.	50500	51500	.21.12.C	212	.47.	50500	51500	.47.12.C	475
.22.	50500	51500	.22.12.C	225	.48.	50500	51500	.48.12.C	487
.23.	50500	51500	.23.12.C	237	.50.	50500	51500	.50.12.C	500
.25.	50500/98500	51500/99500	.25.12.C	250	.51.	50500	51500	.51.12.C	512
.26.	50500	51500	.26.12.C	262	.52.	50500	51500	.52.12.C	525
.27.	50500	51500	.27.12.C	275	.53.	50500	51500	.53.12.C	537
.28.	50500	51500	.28.12.C	287	.55.	50500	51500	.55.12.C	550
.30.	50500/98500	51500/99500	.30.12.C	300	.60.	50500	51500	.60.12.C	600

### Dimensions and order configurations

Part No. structure (pivoting)

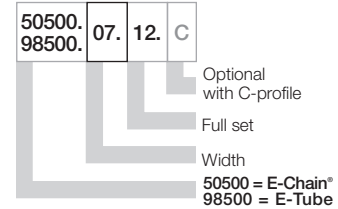

Part No. structure (locking)

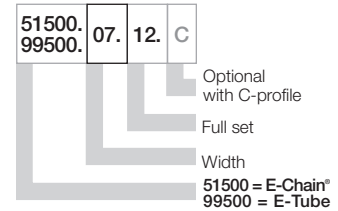

Full set, for both ends:

50500.07.12

Single-part order:

50500.07.1

Mounting bracket moving end

50500.07.2

Mounting bracket fixed end







**Option steel - pivoting**

- For pivoting connections
- One part (two-piece) for all chain widths
- Electrically conductive

Moving end  
50500.1

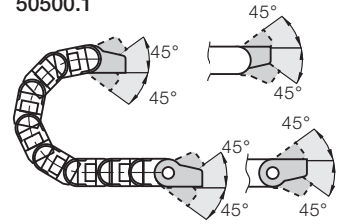

Fixed end  
50500.2

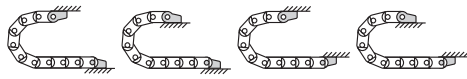

Possible installation conditions -

Further installation angles ► installation sketch

Phone +49- (0) 22 03-96 49-800  
Fax +49- (0) 22 03-96 49-222

igus® GmbH  
51147 Cologne

Internet: [www.igus.eu](http://www.igus.eu)  
E-mail: [info@igus.de](mailto:info@igus.de)

Moving end  
50500.1

Fixed end  
50500.2

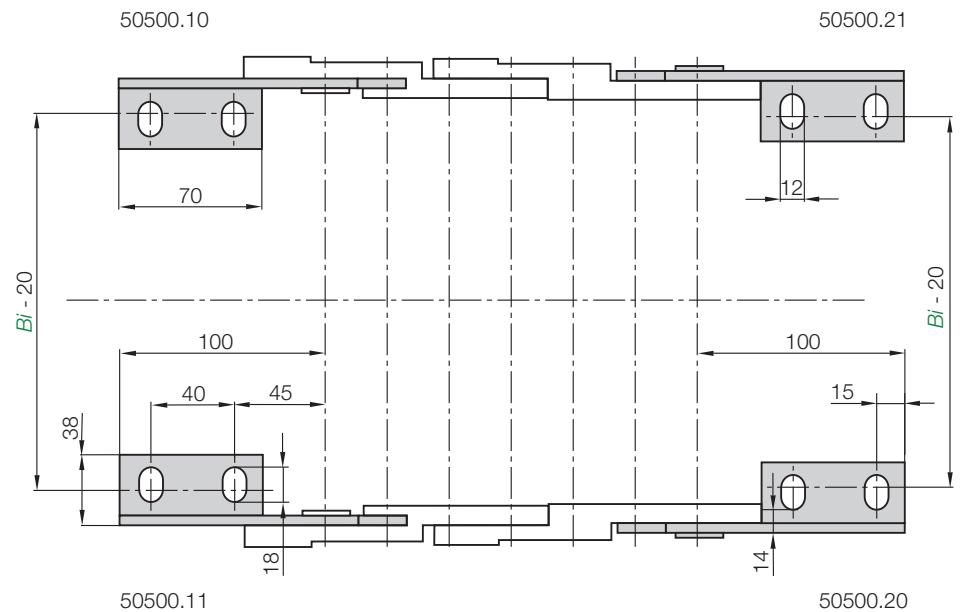

For E-Chain®	Part No. full set	Bi [mm]	For E-Chain®	Part No. full set	Bi [mm]
5050-5150.05	50500.12	50	5050-5150.31	50500.12	312
5050-5150.06	50500.12	65	5050-5150.32	50500.12	325
5050-5150-9850.07	50500.12	75	5050-5150.33	50500.12	337
5050-5150.08	50500.12	87	5050-5150-9850.35	50500.12	350
5050-5150-9850.10	50500.12	100	5050-5150.36	50500.12	362
5050-5150.11	50500.12	112	5050-5150.37	50500.12	375
5050-5150-9850.12	50500.12	125	5050-5150.38	50500.12	387
5050-5150.13	50500.12	137	5050-5150-9850.40	50500.12	400
5050-5150-9850.15	50500.12	150	5050-5150.41	50500.12	412
5050-5150.16	50500.12	162	5050-5150.42	50500.12	425
5050-5150.17	50500.12	175	5050-5150.43	50500.12	437
5050-5150.18	50500.12	187	5050-5150.45	50500.12	450
5050-5150-9850.20	50500.12	200	5050-5150-9850.46	50500.12	462
5050-5150.21	50500.12	212	5050-5150.47	50500.12	475
5050-5150.22	50500.12	225	5050-5150.48	50500.12	487
5050-5150.23	50500.12	237	5050-5150.50	50500.12	500
5050-5150-9850.25	50500.12	250	5050-5150.51	50500.12	512
5050-5150.26	50500.12	262	5050-5150.52	50500.12	525
5050-5150.27	50500.12	275	5050-5150.53	50500.12	537
5050-5150.28	50500.12	287	5050-5150.55	50500.12	550
5050-5150-9850.30	50500.12	300	5050-5150.60	50500.12	600

50500.12 Full set, 4 parts  
2 with pin / 2 with bore

Single-part order:

50500.1 Mounting bracket  
moving end, 1 part left / right

50500.2 Mounting bracket  
fixed end, 1 part left / right

### Chainfix clamps for the C-profile

Part No. single clamps		Part No. double clamps		Part No. triple clamps		Cable ø [mm]
steel	stainless steel	steel	stainless steel	steel	stainless steel	
CFX12.1	CFX12.1.E	CFX12.2	CFX12.2.E	CFX12.3	-	06 - 12
CFX14.1	CFX14.1.E	CFX14.2	CFX14.2.E	CFX14.3	-	12 - 14
CFX16.1	CFX16.1.E	CFX16.2	CFX16.2.E	CFX16.3	-	14 - 16
CFX18.1	CFX18.1.E	CFX18.2	CFX18.2.E	CFX18.3	-	16 - 18
CFX20.1	CFX20.1.E	CFX20.2	CFX20.2.E	CFX20.3	-	18 - 20
CFX22.1	CFX22.1.E	CFX22.2	CFX22.2.E	CFX22.3	-	20 - 22
CFX26.1	CFX26.1.E	CFX26.2	CFX26.2.E	-	-	22 - 26
CFX30.1	CFX30.1.E	CFX30.2	CFX30.2.E	-	-	26 - 30
CFX34.1	CFX34.1.E	CFX34.2	CFX34.2.E	-	-	30 - 34
CFX38.1	CFX38.1.E	-	-	-	-	34 - 38
CFX42.1	CFX42.1.E	-	-	-	-	38 - 42

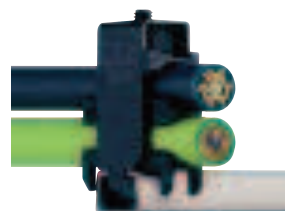

igus® Chainfix steel clamps and Chainfix stainless-steel clamps - max. pull forces, adjustable with hexagon socket. Available as single, double or triple clamps. **Details ▶ chapter 10**

System E4/4  
Inner height: 80 mm

Cable ø [mm]	Part No. clamp	Part No. bottom part
04 - 08	CFC-08-M	CFC-08-C
08 - 12	CFC-12-M	CFC-12-C
12 - 16	CFC-16-M	CFC-16-C
16 - 20	CFC-20-M	CFC-20-C
20 - 24	CFC-24-M	CFC-24-C

### Chainfix Clip - Modular snap-on strain relief device for C-profile

Available for all igus® E-ChainSystems® with C-profiles and also suitable for assembly in the KMA mounting brackets and clip-on strain relief for crossbars. High pull forces, plug-in modular snap-on strain relief device. **Details ▶ chapter 10**

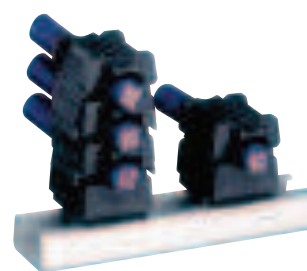

Part No.	ø max. conduit [mm]	Width [mm]
CFN.20	20	10,8
CFN.30.52	30	16,8
CFN.20.N35	20	20,0

### Chainfix Nugget for the C-Profile

Strain relief for the fixation of cables up to a diameter of Ø 30 mm. Easy to assemble, without any screws and tools. Easy strain relief due to fixation with pre-harnessed cable strap, very small space requirement. **Details ▶ chapter 10**



Part No.	Width of strain relief [mm]	Number of teeth
3050.ZC	50	5
3075.ZC	75	7

### Chainfix tiwrap plates with clip-on connection for the C-profile

Can be plugged into the KMA C-profile. Easy to assemble without any screws. Easily solvable with screwdriver nevertheless safe stop. For all E-Chains® with KMA and integrated C-profile. **Details ▶ chapter 10**

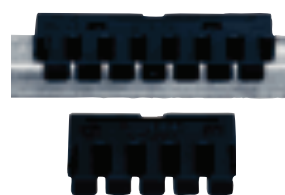

Tiewrap plate	No. of teeth n	Dim. C [mm]	Dim. B [mm]	Center bore
3050.ZB	5	50	30	-
3075.ZB	7	75	55	-
3100.ZB	10	100	80	-
3115.ZB	11	115	95	-
3125.ZB	12	125	105	-
3150.ZB	15	150	130	-
3175.ZB	17	175	155	-
3200.ZB	20	200	180	+
3225.ZB	22	225	205	+
3250.ZB	25	250	230	+

(- = no / + = yes)

### Tiewrap plate as individual part

As individual component screwed on KMA. Can be plugged in the mounting brackets. **Details ▶ chapter 10**

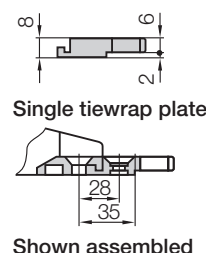
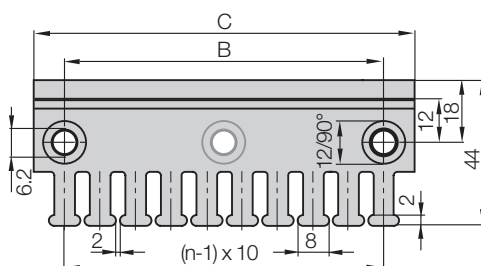

Details about all strain relief option for this series ▶ chapter 10

Phone +49- (0) 22 03-96 49-800  
Fax +49- (0) 22 03-96 49-222



▶ page 7.223

- $B_a$  = Outer width E-Chains® / E-Tube
- $B_i$  = Inner width E-Chains® / E-Tube
- $h_a$  = Outer height E-Chains® / E-Tube
- $H_{Ri}$  = Inner trough height
- $H_{Ra}$  = Outer trough height
- $B_{Ri}$  = Inner trough width ▶ depends on dim.  $B_a$
- $B_{Ra}$  = Outer trough width
- $n_{Mon}$  = Number of installation sets (left/right)
- $n_{Ri}$  = Number of troughs sets (left/right)
- $H_{Ri} \geq 2 \cdot h_a$   
 $B_{Ri} \geq B_a + 4$
- = Guide trough set    ● = Glide bar  
● = Installation set "Basic"    ● = C-profile

### Installation set "Basic" with C-profile

Bottom Clamp attached optionally inwards or outwards

5050.30.300.0 ▶ Order example

	Part No.	Part No.
$B_{Ri}$	attached	attached
[mm]	inwards	outwards
.05	104	960.50.225
.06	119	960.50.250
.07	129	960.50.250
.08	141	960.50.200
.10	154	960.50.225
.11	167	960.50.225
.12	179	960.50.250
.13	192	960.50.250
.15	204	960.50.275
.16	217	960.50.275
.17	229	960.50.300
.18	242	960.50.300
.20	254	960.50.325
.21	267	960.50.325
.22	279	960.50.350
.23	292	960.50.350
.25	304	960.50.375
.26	317	960.50.375
.27	329	960.50.400
.28	342	960.50.400
.30	354	960.50.425
.31	367	960.50.425
.32	379	960.50.450
.33	392	960.50.450
.35	404	960.50.475
.36	417	960.50.475
.37	429	960.50.500
.38	442	960.50.500
.40	454	960.50.525
.41	467	960.50.525
.42	479	960.50.550
.43	492	960.50.550
.45	504	960.50.575
.46	517	960.50.575
.47	529	960.50.600
.48	542	960.50.600
.50	554	960.50.625
.51	567	960.50.625
.52	579	960.50.650
.53	592	960.50.650
.55	604	960.50.675
.60	654	960.50.775

Insert for the installation set "Heavy-Duty": **975.50.XXX** instead of (**960.50.XXX**) on the right column "attached outwards"

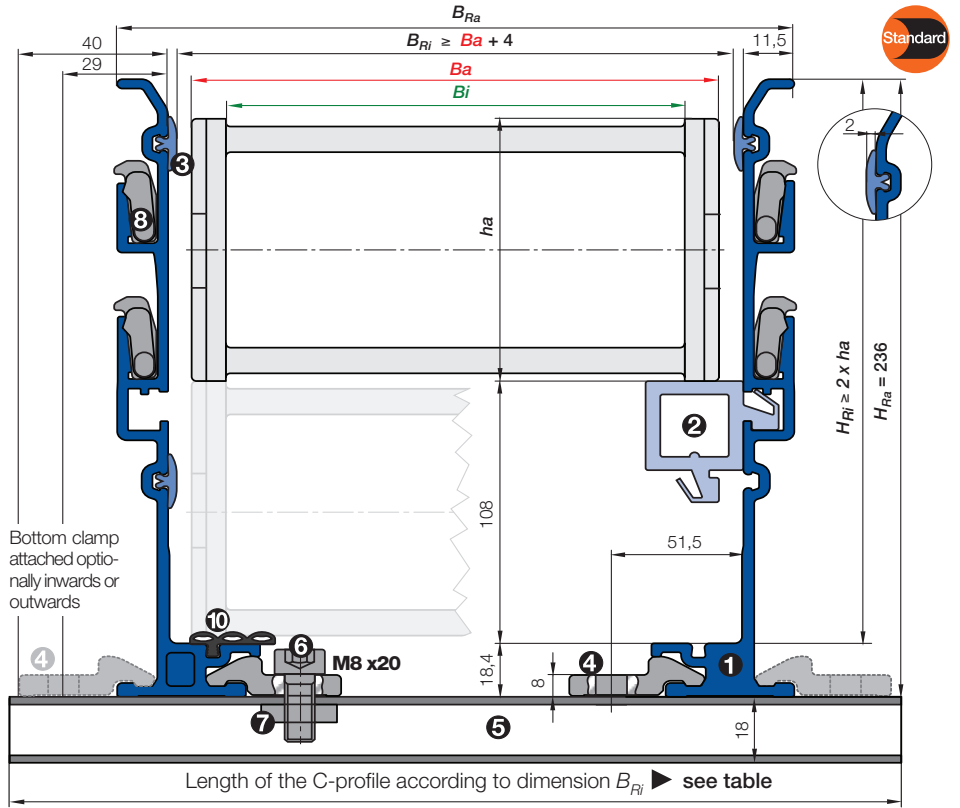

- **Components, trough "Basic":** ① Trough side parts, aluminum, 2 m ② Glide bar, plastic, 2 m ③ Glide strips, plastic, 2 m (without glide strips on request) ⑩ Optional: Silencer profile, rubber
- **Components, installation set "Basic":** ④ Bottom clamp, aluminum ⑤ C-profile, steel galvanized ⑥ Screw M8 x20 ⑦ Sliding nut M8 ⑧ Interface connector, plastic



### Order example: Length of travel 30 m - Center mounted for Series 5050.30.300.0 with $B_{Ri} = 345$

Guide trough set (set of 2 trough side parts, incl. glide strips) **without** glide bar

**Order text: 16 m guide trough without glide bar (8 x 2 m sections) Part No. 975.30.SL**

Guide trough set (set of 2 trough side parts, incl. glide strips) **with** glide bar

**Order text: 16 m guide trough with glide bar (8 x 2 m sections) Part No. 975.31.SL**

Installation set "Basic" complete (guide trough-sets + 1)

**Order text: 17 installation sets "Basic" Part No. 960.50.425**

Module for the fixed end

**Order text: 1 set Part No. 975.80**

**Option:** For an additional noise dampening with silencer profile, please add Index A - Example:

**Part No. 975.30.SLA**

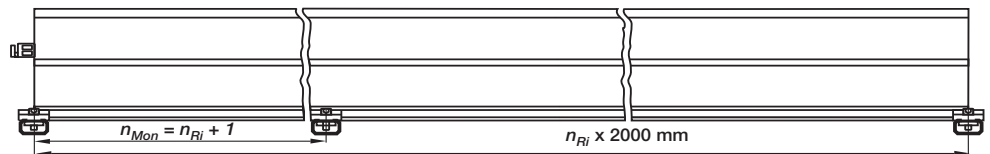

Principle sketch: Number of installation sets to be installed = **Number of trough sections + 1**

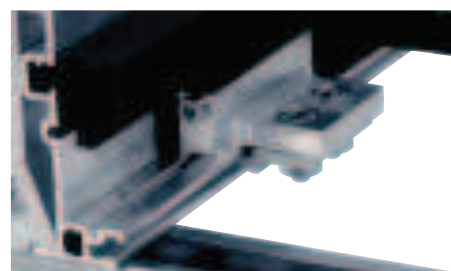

### A quick fix for mounting the stationary end of an E-Chain®

With this module for the fixed end, fast and easy mounting onto the Aluminum "SuperTrough" is now possible without any drilling. Fast mounting of the E-Chain® by clamping onto the aluminum trough

- Quick relocation of the stationary end
- No drilling necessary ▶ page 9.16

Phone +49- (0) 22 03-96 49-800  
Fax +49- (0) 22 03-96 49-222

igus® GmbH  
51147 Cologne

Internet: [www.igus.eu](http://www.igus.eu)  
E-mail: [info@igus.de](mailto:info@igus.de)