

MONO series

Cable carriers for
standard applications

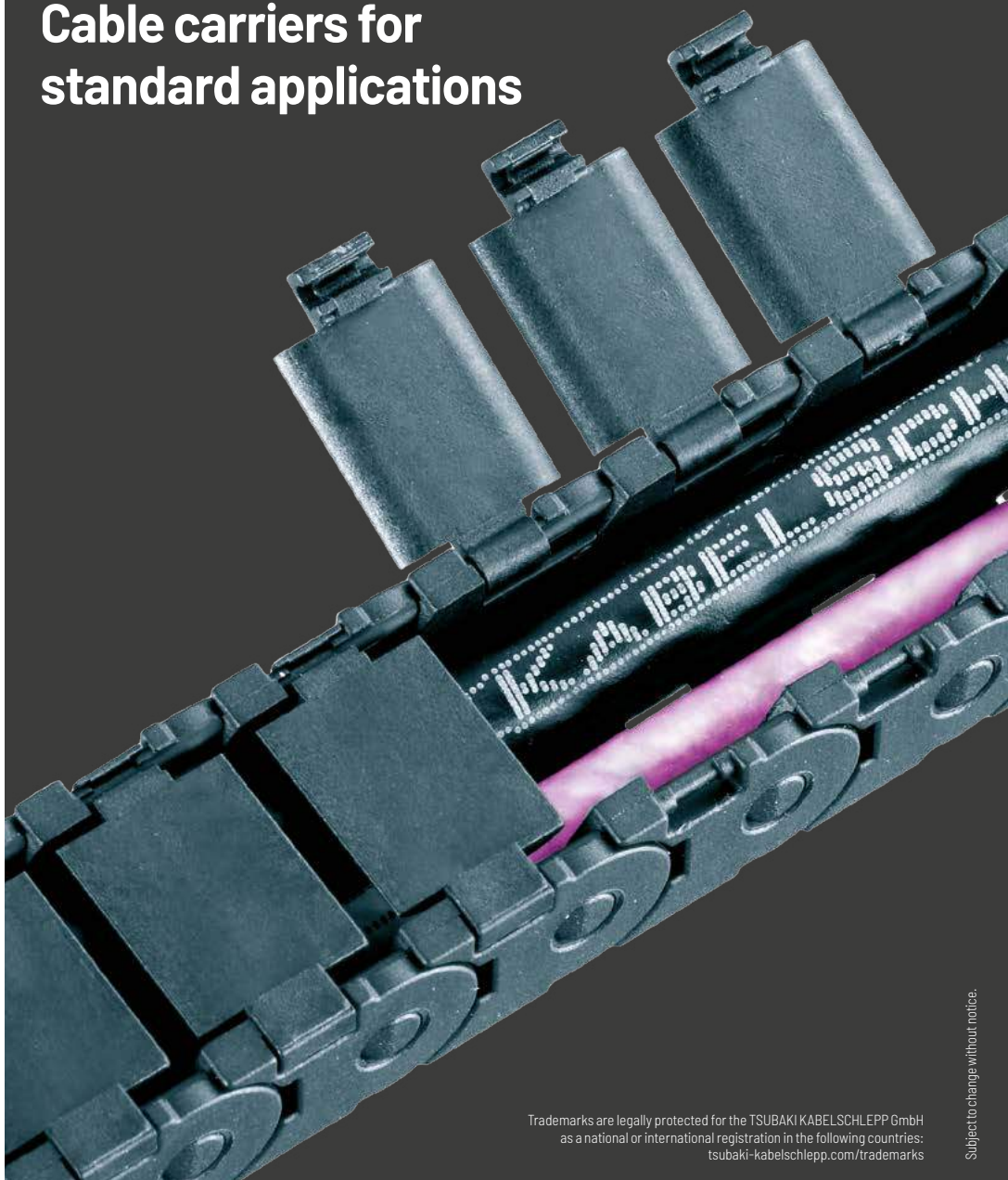

Trademarks are legally protected for the TSUBAKI KABELSCHLEPP GmbH
as a national or international registration in the following countries:
tsubaki-kabelschlepp.com/trademarks

Subject to change without notice.

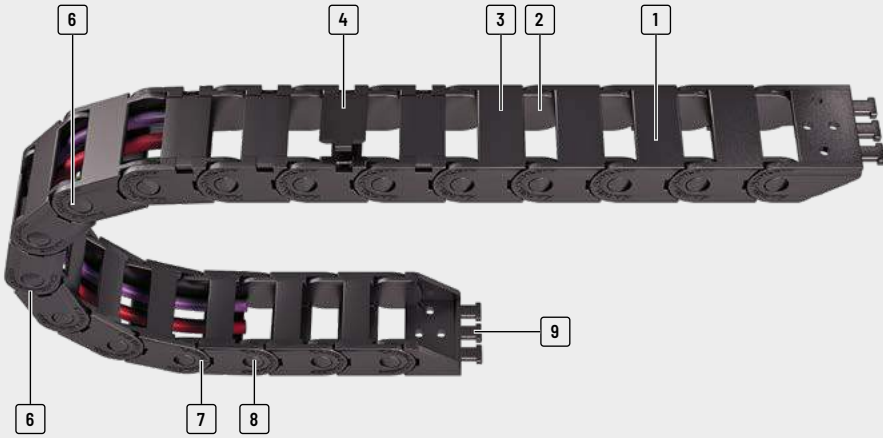

- 1 Plastic chain links
- 2 Inside space is gentle on the cables - no interfering edges
- 3 Types with single-part links
- 4 Types with opening crossbars
- 5 High torsional rigidity through large link surface
- 6 Extensive unsupported length and high additional loads through optimised stroke system
- 7 Easy to shorten and extend
- 8 Long service life through large bolt hole connection
- 9 End connectors with integrated strain relief

Features

- » Cost-effective cable carrier
- » Easy and fast installation
- » Many types available immediately ex-stock world wide
- » Long service life
- » Great unsupported lengths compared to the unit size
- » High torsional rigidity
- » Easy to install



Small types for narrow installation spaces



Fast shortening/extending with push-to-connect chain links



Different connection variants through simple reconnecting of the end connectors

Cable carrier

Cable carrier configuration

Configuration guidelines

Materials information

MONO series

QuickTrax® series

UNIFLEX Advanced series

TKP35 series

TKK series

EasyTrax® series

Type	Opening variant	Stay variant	h_i [mm]	h_G [mm]	B_i [mm]	B_k [mm]	B_i - grid [mm]	t [mm]	KR [mm]	Additional load \leq [kg/m]	Cable- d_{max} [mm]
------	-----------------	--------------	---------------	---------------	---------------	---------------	-------------------------	-----------	------------	-------------------------------------	-----------------------------

MONO 0130/..32/..34



	0132	10	12.5	6 - 20	12 - 26	-	13	20 - 37	0.5	8
	0130	10	12.5	6 - 20	12 - 26	-	13	20 - 37	0.5	8
	0134	10	12.5	6 - 20	12 - 26	-	13	20 - 37	0.5	8

MONO 0180/..82/..84



	0182	15	18	10 - 40	18 - 48	-	18	28 - 50	1	12
	0180	15	18	10 - 40	18 - 48	-	18	28 - 50	1	12
	0184	15	18	10 - 40	18 - 48	-	18	28 - 50	1	12

MONO 0202



	0202	11	15	6 - 20	13 - 27	-	20	18 - 50	1.25	8.5
--	------	----	----	--------	---------	---	----	---------	------	-----

Cable carrier

Cable carrier
configurationConfiguration
guidelinesMaterials
informationMONO
seriesQuickTrax®
seriesUNIFLEX
Advanced
seriesTKP35
seriesTKK
seriesEasyTrax®
series

Unsupported arrangement			Gliding arrangement			Inner Distribution				Movement			Page
Travel length ≤ [m]	v_{max} ≤ [m/s]	a_{max} ≤ [m/s ²]	Travel length ≤ [m]	v_{max} ≤ [m/s]	a_{max} ≤ [m/s ²]	TS0	TS1	TS2	TS3	vertical hanging or standing	lying on the side	rotating arrangement	
1.15	10	50	40	3	30	-	-	-	-	•	•	-	112
1.15	10	50	40	3	30	-	-	-	-	•	•	-	113
1.15	10	50	-	-	-	-	-	-	-	•	•	-	114
1.55	10	50	70	3	30	-	-	-	-	•	•	-	118
1.55	10	50	70	3	30	-	-	-	-	•	•	-	119
1.55	10	50	-	-	-	-	-	-	-	•	•	-	120
1.95	10	50	70	3	30	-	-	-	-	•	•	•	124

Cable carrier

Cable carrier configuration

Configuration guidelines

Materials information

MONO series

QuickTrax® series

UNIFLEX Advanced series

TKP35 series

TKK series

EasyTrax® series

0130/.32/.34

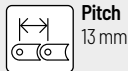

Pitch
13 mm



Inner height
10 mm



Inner widths
6 – 20 mm

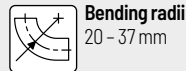

Bending radii
20 – 37 mm

Types



Type 0132 page 112

Closed frame (design 020)

- » Weight optimised, closed plastic frame with high torsional rigidity.
- » **Outside/inside:** not openable.



Type 0130 page 113

Frame with outside opening crossbars (design 030)

- » Weight optimised plastic frame with high torsional rigidity.
- » Openable at any position.
- » **Outside:** openable.



Type 0134 page 114

Frame with inside opening crossbars (design 040)

- » Weight optimised plastic frame with high torsional rigidity.
- » Openable at any position.
- » **Inside:** openable.

Optimised cable carrier geometry:

Easy to shorten and extend

Long service life through large bolt hole connection

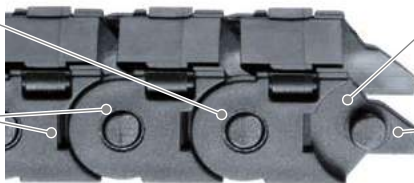

High torsional rigidity through large link surface

Extensive unsupported length and high additional loads through optimised stroke system

Unsupported arrangement

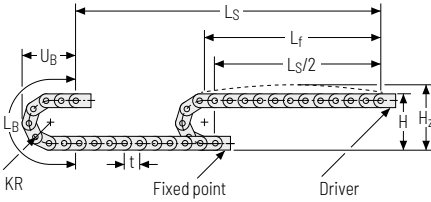





KR [mm]	H [mm]	H _z [mm]	L _B [mm]	U _B [mm]
20	52.5	62.5	89	40
28	68.5	78.5	114	48
37	86.5	96.5	142	57

Load diagram for unsupported length depending on the additional load.

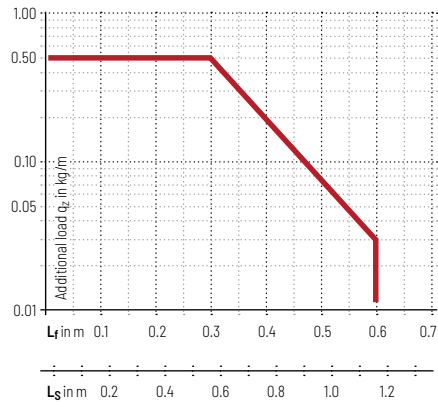
Sagging of the cable carrier is technically permitted for extended travel lengths, depending on the specific application.





Intrinsic cable carrier weight $q_k = 0.16 \text{ kg/m}$ with B_1 15 mm. For other inner widths, the maximum additional load changes.

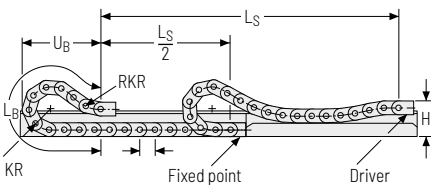

-  **Speed**
up to 10 m/s
-  **Acceleration**
up to 50 m/s^2
-  **Travel length**
up to 1.15 m
-  **Additional load**
up to 0.5 kg/m

Gliding arrangement



-  **Speed**
up to 3 m/s
-  **Acceleration**
up to 30 m/s^2
-  **Travel length**
up to 40 m
-  **Additional load**
up to 0.5 kg/m

 The gliding cable carrier must be guided in a channel. See p. 842.

Only designs 020 and 030 can be used for a gliding arrangement.

Subject to change without notice.

Cable carrier
Cable carrier configuration
Configuration guidelines
Materials information
MONO series
QuickTrax® series
UNIFLEX Advanced series
TKP35 series
TKK series
EasyTrax® series

Type 0132 – closed frame

- » Weight optimised, closed plastic frame with high torsional rigidity.
- » **Outside/inside:** not openable.



Stay arrangement on each chain link (**VS: fully-stayed**)



B₇ 6 – 20 mm

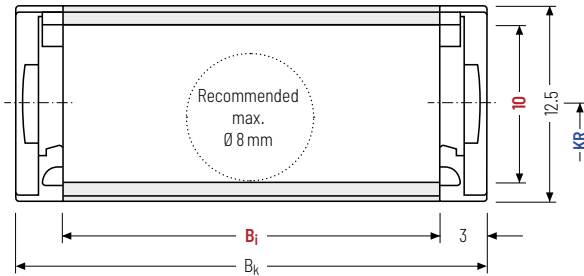

The maximum cable diameter strongly depends on the bending radius and the desired cable type. Please contact us.

Calculating the cable carrier length

Cable carrier length L_k

$$L_k \approx \frac{L_S}{2} + L_B$$

Cable carrier length L_k
rounded to pitch t

h_i [mm]	h_G [mm]	B_i [mm]			B_k [mm]	KR [mm]			q_k [kg/m]	
10	12.5	6	10	15	20	$B_i + 6$	20	28	37	0.091 – 0.162

Order example



MONO
Series

0132
Type

15
 B_i [mm]

28
 KR [mm]

390
 L_k [mm]

VS
Stay arrangement

Cable carrier

Cable carrier configuration

Configuration guidelines

Materials information

MONO series

QuickTrax® series

UNIFLEX Advanced series

TKP35 series

TKK series

EasyTrax® series

Type 0130 - with outside opening crossbars

- » Weight optimised plastic frame with high torsional rigidity.
- » Openable at any position.
- » **Outside:** openable.

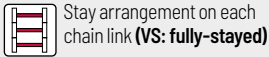

Stay arrangement on each chain link (VS: fully-stayed)



$B_i = 20$ mm

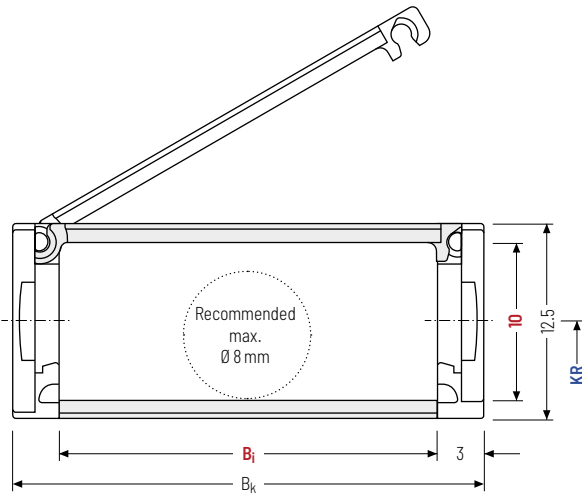

i The maximum cable diameter strongly depends on the bending radius and the desired cable type. Please contact us.

Calculating the cable carrier length

Cable carrier length L_k

$$L_k \approx \frac{L_S}{2} + L_B$$

Cable carrier length L_k rounded to pitch t

h_i [mm]	h_G [mm]	B_i [mm]				B_k [mm]	KR [mm]			q_k [kg/m]
10	12.5	6	10	15	20	$B_i + 6$	20	28	37	0.097 - 0.178

Order example



Cable carrier

Cable carrier configuration

Configuration guidelines

Materials information

MONO series

QuickTrax® series

UNIFLEX Advanced series

TKP35 series

TKK series

EasyTrax® series

Type 0134 – with inside opening crossbars

- » Weight optimised plastic frame with high torsional rigidity.
- » Openable at any position.
- » **Outside:** openable.



Stay arrangement on each chain link (**VS: fully-stayed**)



$B_i + 20$ mm

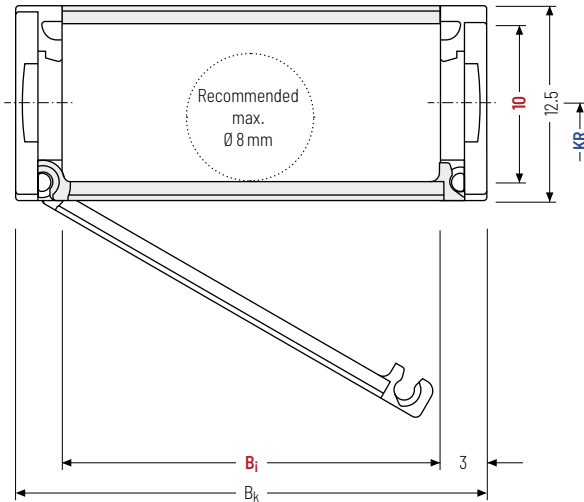

The maximum cable diameter strongly depends on the bending radius and the desired cable type. Please contact us.

Calculating the cable carrier length

Cable carrier length L_k

$$L_k \approx \frac{L_S}{2} + L_B$$

Cable carrier length L_k
rounded to pitch t

h_i [mm]	h_G [mm]	B_i [mm]			B_k [mm]	KR [mm]			q_k [kg/m]	
10	12.5	6	10	15	20	$B_i + 6$	20	28	37	0.099 – 0.132

Order example



MONO
Series

0134
Type

15
 B_i [mm]

28
 KR [mm]

390
 L_k [mm]

VS
Stay arrangement

Single-part end connectors – plastic
(with integrated strain relief)

The plastic end connectors can be connected **from above or below**. The connection type can be changed by altering the position of the end connector.

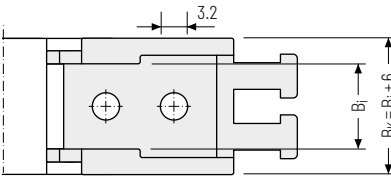
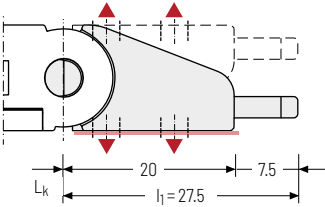

Single-part end connectors – plastic

The plastic end connectors can be connected **from above or below**. The connection type can be changed by altering the position of the end connector.

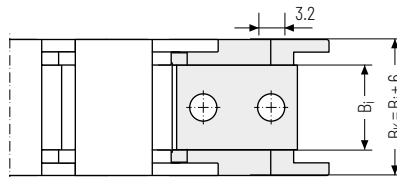
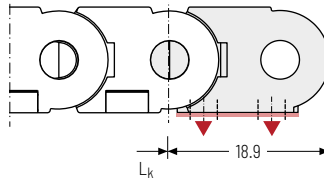

▲ Assembly options

Connection point
F – fixed point
M – driver

Connection type
A – threaded joint outside (standard)
I – threaded joint inside

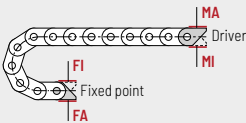

Connection point
F – fixed point
M – driver

Connection type
A – threaded joint outside (standard)
I – threaded joint inside

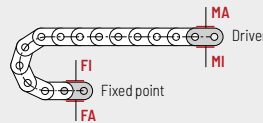

Order example

 .

.

End connector Connection point Connection type

 Depending on the design, the connection angles can be swivelled up to 12°.

Cable carrier
Cable carrier configuration
Configuration guidelines
Materials information
MONO series
QuickTrax® series
UNIFLEX Advanced series
TKP35 series
TKK series
EasyTrax® series

0180/.82/.84



Pitch
18 mm



Inner height
15 mm



Inner widths
10 – 40 mm



Bending radii
28 – 50 mm

Types



Type 0182 page 118

Closed frame (design 020)

- » Weight optimised, closed plastic frame with high torsional rigidity.
- » **Outside/inside:** not openable.



Type 0180 page 119

Frame with outside opening crossbars (design 030)

- » Weight optimised plastic frame with high torsional rigidity.
- » Openable at any position.
- » **Outside:** openable.



Type 0184 page 120

Frame with inside opening crossbars (design 040)

- » Weight optimised plastic frame with high torsional rigidity.
- » Openable at any position.
- » **Inside:** openable.

Optimised cable carrier geometry:

Easy to shorten and extend

Long service life through large bolt hole connection

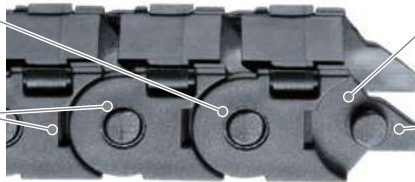

High torsional rigidity through large link surface

Extensive unsupported length and high additional loads through optimised stroke system

Unsupported arrangement

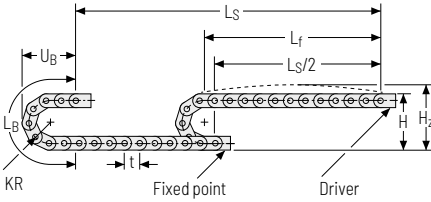





KR [mm]	H [mm]	H _Z [mm]	L _B [mm]	U _B [mm]
28	74	89	124	55
37	92	107	153	64
50	118	133	194	77

Load diagram for unsupported length depending on the additional load.

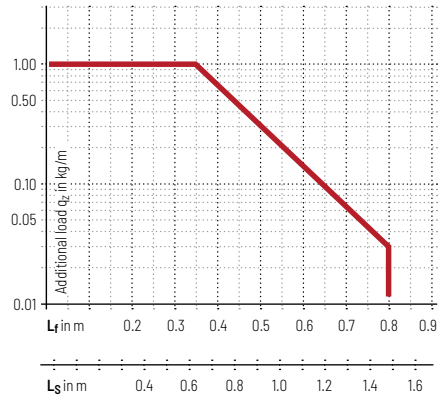
Sagging of the cable carrier is technically permitted for extended travel lengths, depending on the specific application.





Intrinsic cable carrier weight $q_k = 0.25 \text{ kg/m}$ with B_i 10 mm. For other inner widths, the maximum additional load changes.

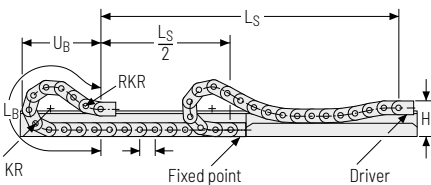

-  **Speed**
up to 10 m/s
-  **Acceleration**
up to 50 m/s^2
-  **Travel length**
up to 1.5 m
-  **Additional load**
up to 1.0 kg/m

Gliding arrangement



-  **Speed**
up to 3 m/s
-  **Acceleration**
up to 30 m/s^2
-  **Travel length**
up to 70 m
-  **Additional load**
up to 1.0 kg/m

 The gliding cable carrier must be guided in a channel. See p. 842.

Only designs 020 and 030 can be used for a gliding arrangement.

Cable carrier
Cable carrier configuration
Configuration guidelines
Materials information
MONO series
QuickTrax® series
UNIFLEX Advanced series
TKP35 series
TKK series
EasyTrax® series

Type 0182 – closed frame

- » Weight optimised, closed plastic frame with high torsional rigidity.
- » **Outside/inside:** not openable.



Stay arrangement on each chain link (**VS: fully-stayed**)



B_i 10 – 40 mm

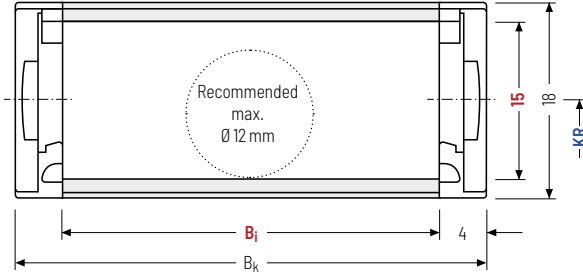

The maximum cable diameter strongly depends on the bending radius and the desired cable type. Please contact us.

Calculating the cable carrier length

Cable carrier length L_k

$$L_k \approx \frac{L_S}{2} + L_B$$

Cable carrier length L_k
rounded to pitch t

h_i [mm]	h_g [mm]	B_i [mm]				B_k [mm]	KR [mm]			q_k [kg/m]	
15	18	10	15	20	30	40	$B_i + 8$	28	37	50	0.123 – 0.186

Order example



MONO

Series

0182

Type

30

B_i [mm]

37

KR [mm]

720

L_k [mm]

VS

Stay arrangement

Type 0180 - with outside opening crossbars

- » Weight optimised plastic frame with high torsional rigidity.
- » Openable at any position.
- » **Outside:** openable.



 Stay arrangement on each chain link (**VS: fully-stayed**)

 B_i 10 - 40 mm

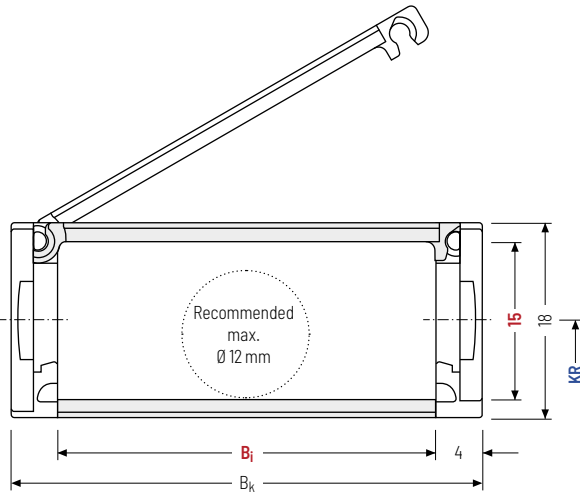

 The maximum cable diameter strongly depends on the bending radius and the desired cable type. Please contact us.

Calculating the cable carrier length

Cable carrier length L_k

$$L_k \approx \frac{L_S}{2} + L_B$$

Cable carrier length L_k rounded to pitch t

h_i [mm]	h_g [mm]	B_i [mm]			B_k [mm]	KR [mm]			q_k [kg/m]		
15	18	10	15	20	30	40	$B_i + 8$	28	37	50	0.169 - 0.252

Order example

 **MONO** Series · **0180** Type · **30** B_i [mm] · **37** KR [mm] · **720** L_k [mm] · **VS** Stay arrangement

Cable carrier

Cable carrier configuration

Configuration guidelines

Materials information

MONO series

QuickTrax® series

UNIFLEX Advanced series

TKP35 series

TKK series

EasyTrax® series

Type 0184 - with inside opening crossbars

- » Weight optimised plastic frame with high torsional rigidity.
- » Openable at any position.
- » **Inside:** openable.



Stay arrangement on each chain link (**VS: fully-stayed**)



B_i 10 - 40 mm

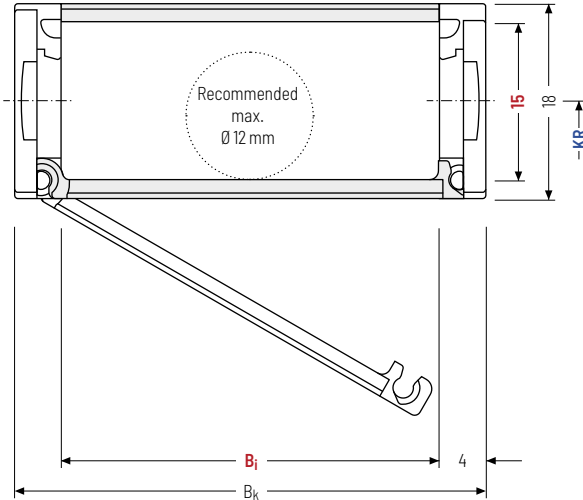

The maximum cable diameter strongly depends on the bending radius and the desired cable type. Please contact us.

Calculating the cable carrier length

Cable carrier length L_k

$$L_k \approx \frac{L_S}{2} + L_B$$

Cable carrier length L_k
rounded to pitch t

h_i [mm]	h_g [mm]	B_i [mm]			B_k [mm]	KR [mm]			q_k [kg/m]		
15	18	10	15	20	30	40	$B_i + 8$	28	37	50	0.133

Order example



MONO
Series

0184
Type

15
 B_i [mm]

37
 KR [mm]

720
 L_k [mm]

VS
Stay arrangement

Single-part end connectors – plastic
(with integrated strain relief)

The plastic end connectors can be connected **from above or below**. The connection type can be changed by altering the position of the end connector.

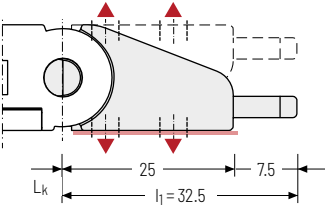

Bj: 10/15/20

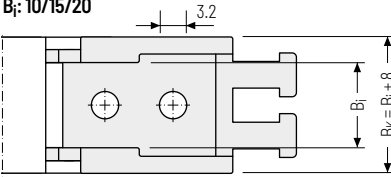

Bj: 30/40

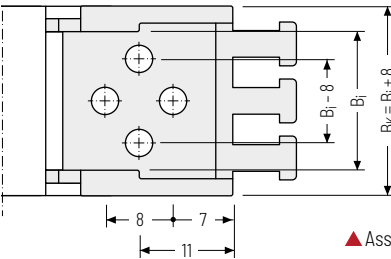

Single-part end connectors – plastic

The plastic end connectors can be connected **from above or below**. The connection type can be changed by altering the position of the end connector.

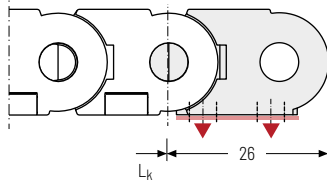

Bj: 10/15/20

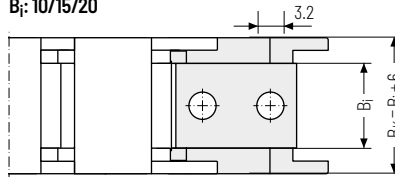

Bj: 30/40

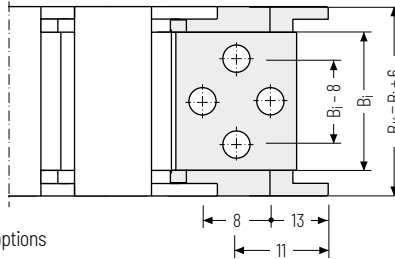

▲ Assembly options

Connection point

- F** – fixed point
- M** – driver

Connection type

- A** – threaded joint outside (standard)
- I** – threaded joint inside

Connection point

- F** – fixed point
- M** – driver

Connection type

- A** – threaded joint outside (standard)
- I** – threaded joint inside

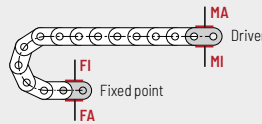
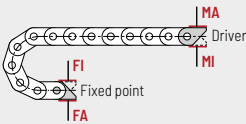

Order example

	End connector	.	F	A
	End connector	.	M	A
	End connector		Connection point	Connection type

Cable carrier
Cable carrier configuration
Configuration guidelines
Materials information
MONO series
QuickTrax® series
UNIFLEX Advanced series
TKP35 series
TKK series
EasyTrax® series

0202



Pitch
20 mm



Inner height
11 mm



Inner widths
6 - 20 mm



Bending radii
18 - 50 mm

Types



Type 0202..... page 124

Closed frame (design 020)

- » Weight optimised, closed plastic frame with high torsional rigidity.
- » **Outside/inside:** not openable.

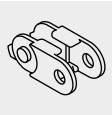

Fast cable laying – 0202 slotted version

The slotted variant of the MONO 0202 allows fast and easy pressing in of cables without opening the cable carrier. That saves time and therefore money. It is particularly suitable for cables with pre-assembled connectors. Please contact us!



Unsupported arrangement

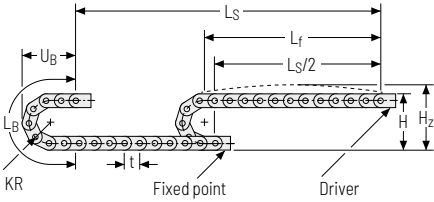

KR [mm]	H [mm]	H ₂ [mm]	L _B [mm]	U _B [mm]
18	51	61	97	45,5
28	71	81	128	55,5
38	91	101	160	65,5
50	115	125	198	77,5

Load diagram for unsupported length depending on the additional load.

Sagging of the cable carrier is technically permitted for extended travel lengths, depending on the specific application.

Intrinsic cable carrier weight $q_k = 0.18 \text{ kg/m}$ with $B_3 10 \text{ mm}$. For other inner widths, the maximum additional load changes.

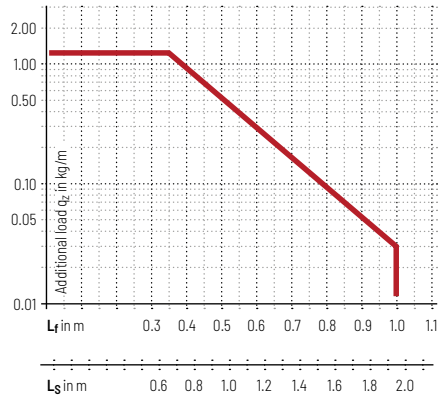

Speed
up to 10 m/s

Acceleration
up to 50 m/s^2

Travel length
up to 1.95 m

Additional load
up to 1.25 kg/m

Cable carrier
Cable carrier configuration
Configuration guidelines
Materials information

MONO series

QuickTrax® series

UNIFLEX Advanced series

TKP35 series

TKK series

EasyTrax® series

Gliding arrangement

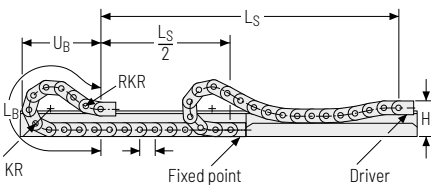

Speed
up to 3 m/s

Acceleration
up to 30 m/s^2

Travel length
up to 70 m

Additional load
up to 1.25 kg/m

The gliding cable carrier must be guided in a channel. See p. 842.

Type 0202 - closed frame

- » Weight optimised, closed plastic frame with high torsional rigidity.
- » **Outside/inside:** not openable.



Stay arrangement on each chain link (**VS: fully-stayed**)



$B_i 6 - 20$ mm

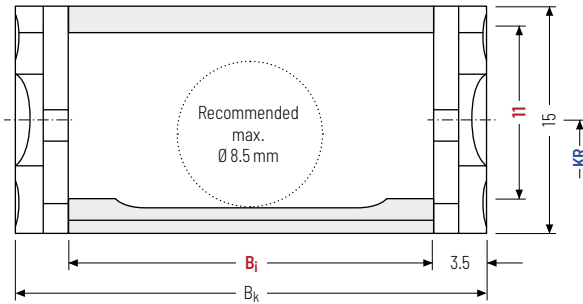

The maximum cable diameter strongly depends on the bending radius and the desired cable type. Please contact us.

Calculating the cable carrier length

Cable carrier length L_k

$$L_k \approx \frac{L_S}{2} + L_B$$

Cable carrier length L_k
rounded to pitch t

h_i [mm]	h_g [mm]	B_i [mm]			B_k [mm]	KR [mm]				q_k [kg/m]	
11	15	6	10	15	20	$B_i + 7$	18	28	38	50	0.14 - 0.17

Order example



MONO

Series

0202

Type

10

B_i [mm]

28

KR [mm]

460

L_k [mm]

VS

Stay arrangement

Single-part end connectors – plastic (with integrated strain relief)

The plastic end connectors can be **connected from above or below**. The connection type can be changed by altering the position of the end connector.

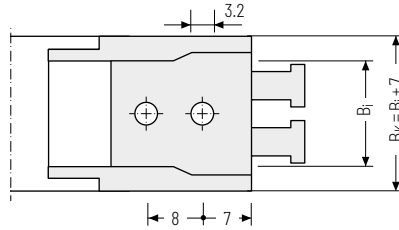
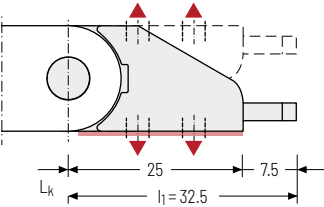

▲ Assembly options

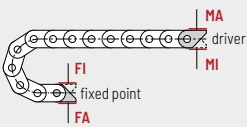

Connection point

- F - fixed point
- M - driver

Connection type

- A - threaded joint outside (standard)
- I - threaded joint inside

Order example

	End connector	.	F	A
	End connector	.	M	A
	End connector		Connection point	Connection type

Additional product information online



Installation instructions, etc.:
Additional info via your smartphone or check online at tsubaki-kabelschlepp.com/downloads



Configure your cable carrier here:
online-engineer.de

Cable carrier
Cable carrier configuration
Configuration guidelines
Materials information
MOND series
QuickTrax® series
UNIFLEX Advanced series
TKP35 series
TKK series
EasyTrax® series