

XLT series

**Tubes with variable
cable carrier widths**

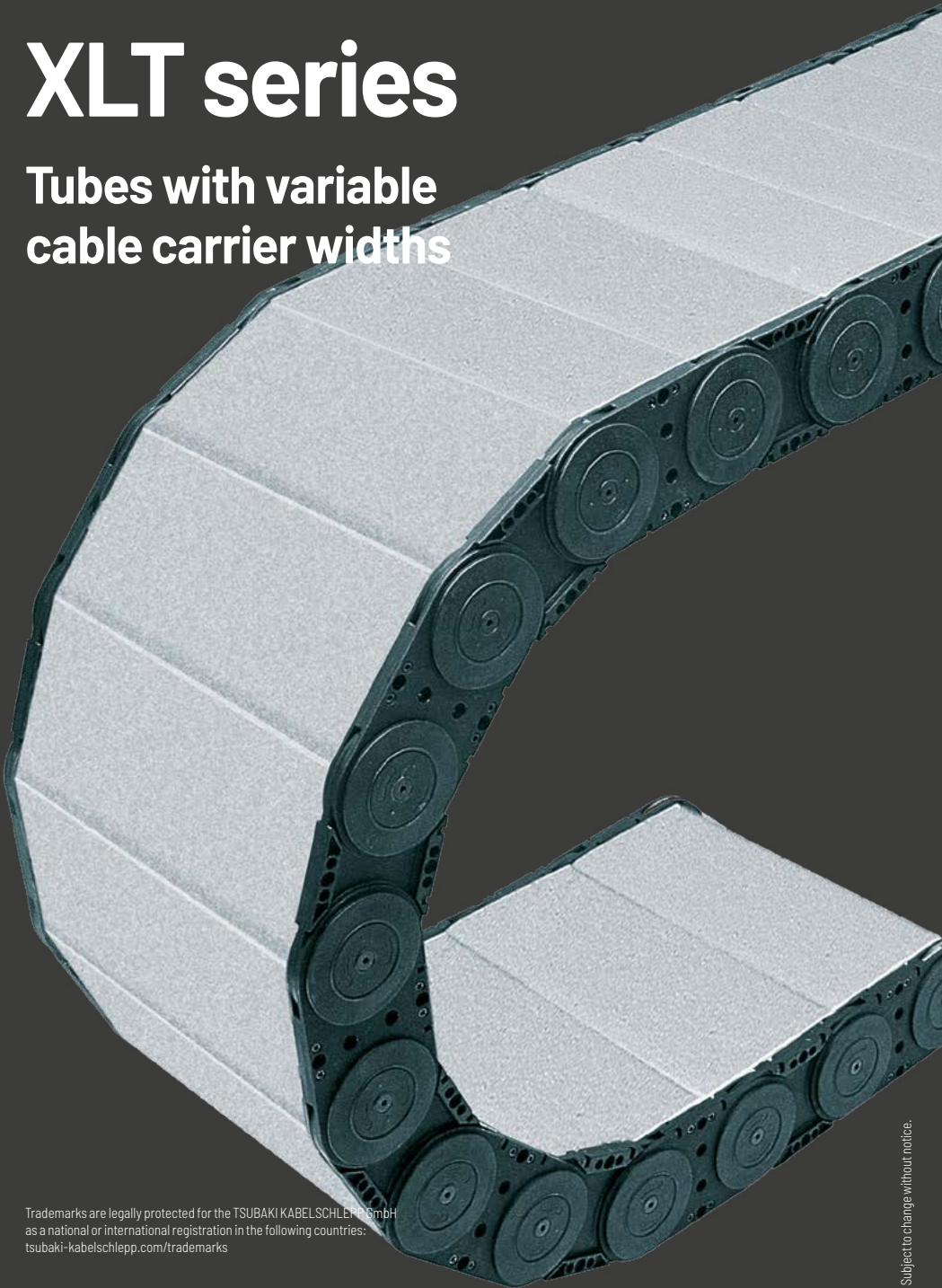

Trademarks are legally protected for the TSUBAKI KABELSCHLEPP GmbH as a national or international registration in the following countries:
tsubaki-kabelschlepp.com/trademarks

Subject to change without notice.

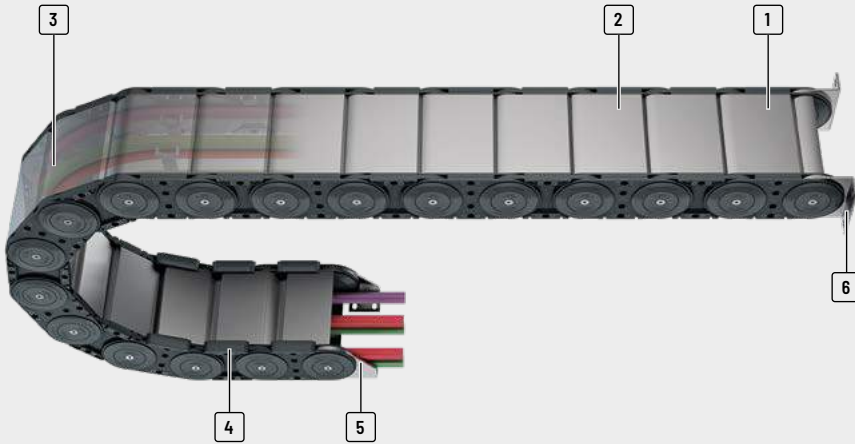

- 1 Aluminum covers available in **1 mm width sections**
- 2 4 screw-fixing points for extreme loads
- 3 Can be opened on the inside and the outside for installation of cables and hoses
- 4 Replaceable glide shoes
- 5 Sturdy end connectors made of steel
- 6 Flange connection

Features

- » Sizes/dimensions
- » Low intrinsic weight
- » Optimum force transmission via the large-surface stroke system (2 disc principle)
- » Plastic side bands in combination with aluminum stays
- » Versions with aluminum stays available in 1 mm width sections up to 1000 mm inner width
- » Can be opened on both sides
- » Large selection of separating options for cables and hoses
- » Optionally with strain relief



Bolted covers systems for maximum stability even for large cable carrier widths



Replaceable glide shoes for long service life for gliding applications



Sturdy end connectors made of steel (different connection variants)



Many separation options for the cables

Type	Opening variant	Stay variant	h_i [mm]	h_G [mm]	B_i [mm]	B_k [mm]	B_i - grid [mm]	t [mm]	KR [mm]	Additional load ≤ [kg/m]	Cable- d_{max} [mm]

XLT1650



	RMD	105	140	200 - 1000	268 - 1068	1	165	300 - 550	65	84
--	-----	-----	-----	------------	------------	---	-----	-----------	----	----

- TRAXLINE®
- Accessories
- S/SX-Tubes series
- S/SX series
- LS/LSX series
- CLEANVEYOR®
- FLATVEYOR®
- ROBOTRAX® System
- XLT series
- MT series

Unsupported arrangement			Gliding arrangement			Inner Distribution				Movement			Page
Travel length ≤ [m]	v_{max} ≤ [m/s]	a_{max} ≤ [m/s ²]	Travel length ≤ [m]	v_{max} ≤ [m/s]	a_{max} ≤ [m/s ²]	TS0	TS1	TS2	TS3	vertical hanging or standing	lying on the side	rotating arrangement	

11.75	4	25	350	2	2-3	•	-	-	•	•	•	-	662
-------	---	----	-----	---	-----	---	---	---	---	---	---	---	-----

Subject to change without notice.

TRAXLINE®	Accessories	S/SX-Tubes series	S/SX series	LS/LSX series	CLEANVEYOR®	FLATVEYOR®	ROBOTRAX® System	XLT series	MT series
-----------	-------------	-------------------	-------------	---------------	-------------	------------	------------------	------------	-----------

XLT1650



Pitch
165 mm



Inner heights
105 mm



Inner widths
200 - 1000 mm



Bending radii
300 - 550 mm

Stay variants



Aluminum stay RMD page **662**

Aluminum cover system

- » Bolted aluminum covers for maximum stability
- » For applications generating swarf or coarse contamination
- » **Inside/outside:** Threaded joint easy to release.

Unsupported arrangement

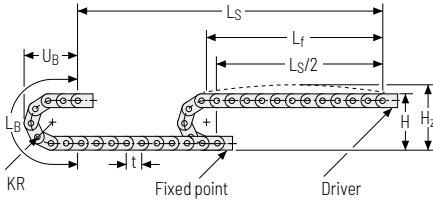





KR [mm]	H [mm]	H _z [mm]	L _B [mm]	U _B [mm]
300	740	840	1272	535
350	840	940	1430	585
400	940	1040	1587	635
450	1040	1140	1744	685
500	1140	1240	1901	735
550	1240	1340	2058	785

Load diagram for unsupported length depending on the additional load.

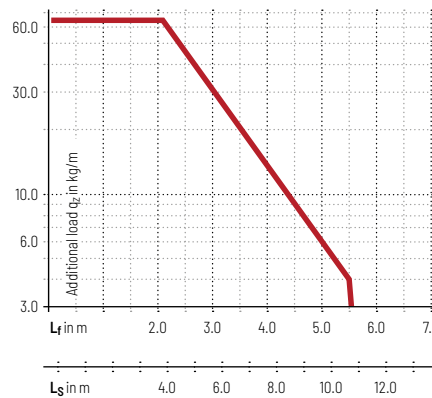
Sagging of the cable carrier is technically permitted for extended travel lengths, depending on the specific application.





Intrinsic cable carrier weight $q_k = 13 \text{ kg/m}$. For other inner widths, the maximum additional load changes.

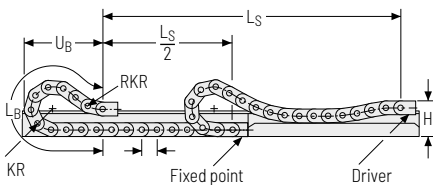

-  **Speed**
up to 4 m/s
-  **Acceleration**
up to 25 m/s²
-  **Travel length**
up to 11.75 m
-  **Additional load**
up to 65 kg/m

Gliding arrangement



-  **Speed**
up to 2 m/s
-  **Acceleration**
up to 2-3 m/s²
-  **Travel length**
up to 350 m
-  **Additional load**
up to 65 kg/m

 The gliding cable carrier must be guided in a channel. See p. 842.

We recommend the use of glide shoes for gliding applications.

MT series
XLT series
ROBOTRAX® System
FLATVEYOR®
CLEANVEYOR®
LS/LSX series
S/SX series
S/SX-Tubes series
Accessories
TRAXLINE®

Aluminum stay RMD – aluminum cover system

- » Bolted aluminum covers for maximum stability
- » For applications generating swarf or coarse contamination
- » Available customized in **1 mm grid**.
- » **Inside/outside:** Threaded joint easy to release.



Stay arrangement on each chain link (**VS: fully-stayed**)



1 mm B_i: 200 – 1000 mm
in 1 mm width sections

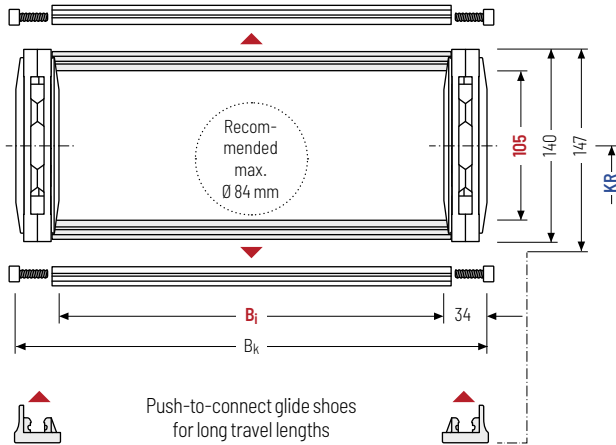

The maximum cable diameter strongly depends on the bending radius and the desired cable type. Please contact us.

Calculating the cable carrier length

Cable carrier length L_k

$$L_k \approx \frac{L_S}{2} + L_B$$

Cable carrier length L_k
rounded to pitch t

h_j [mm]	h_G [mm]	h_G' [mm]	B_i [mm]*	B_k [mm]	KR [mm]				q_k [kg/m]		
105	140	147	200 – 1000	$B_i + 68$	300	350	400	450	500	550	10.5 – 15.3

* in 1 mm width sections

Order example



XLT1650

Type

420

B_i [mm]

RMD

Stay variant

350

KR [mm]

2850

L_k [mm]

VS

Stay arrangement

Divider systems

The divider system is mounted on each crossbar as a standard – on every 2nd chain link for stay mounting (HS).

As a standard, dividers or the complete divider system (dividers with height separations) are movable in the cross section (**version A**).

Divider system TSO without height separation

Vers.	a _T min [mm]	a _x min [mm]	a _c min [mm]	n _T min
A	6	25	17	-

The dividers can be moved in the cross section.

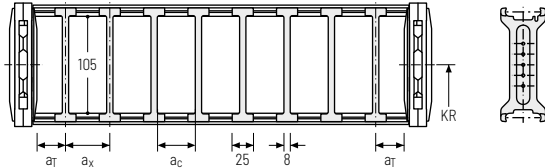

Divider system TS3 with height separation consisting of plastic partitions

Vers.	a _T min [mm]	a _x min [mm]	a _c min [mm]	n _T min
A	1	16 / 42*	8	2

* For aluminum partitions

The dividers are fixed with the partitions. The entire divider system can be moved in the cross section.

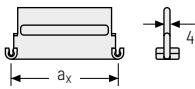
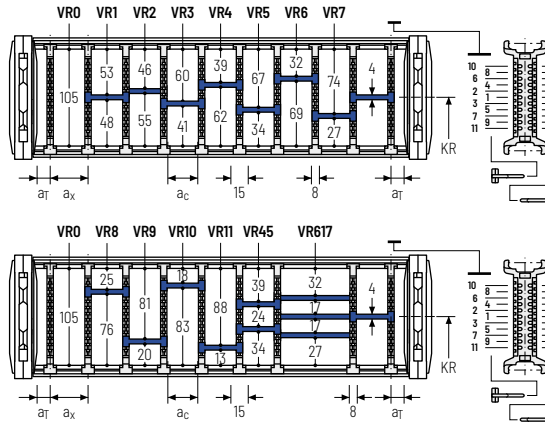

Aluminum partitions in 1 mm increments with a_x > 42 mm are also available.

a _x (center distance of dividers) [mm]											
a _c (nominal width of inner chamber) [mm]											
16	18	23	28	32	33	38	43	48	58	64	68
8	10	15	20	24	25	30	35	40	50	56	60
78	80	88	96	112	128	144	160	176	192	208	
70	72	80	88	104	120	136	152	168	184	200	

When using plastic partitions with a_x > 112 mm, we recommend an additional center support with a twin divider (S_T = 5 mm). Twin dividers are also suitable for retrofitting in the partition system.

Order example

TS3

A

3

K1

34

VR1

.

K4

38

VR3

Divider system

Version

n_T

Chamber

a_x

Height separation

Please state the designation of the divider system (**TS0, TS3**), the version, and the number of dividers per cross section [n_T]. In addition, please also enter the chambers [K] from left to right, as well as the assembly distances [a_T/a_x].

End connectors - steel

End connectors made of steel. The connection variants on the fixed point and on the driver can be combined and changed later on, if necessary.

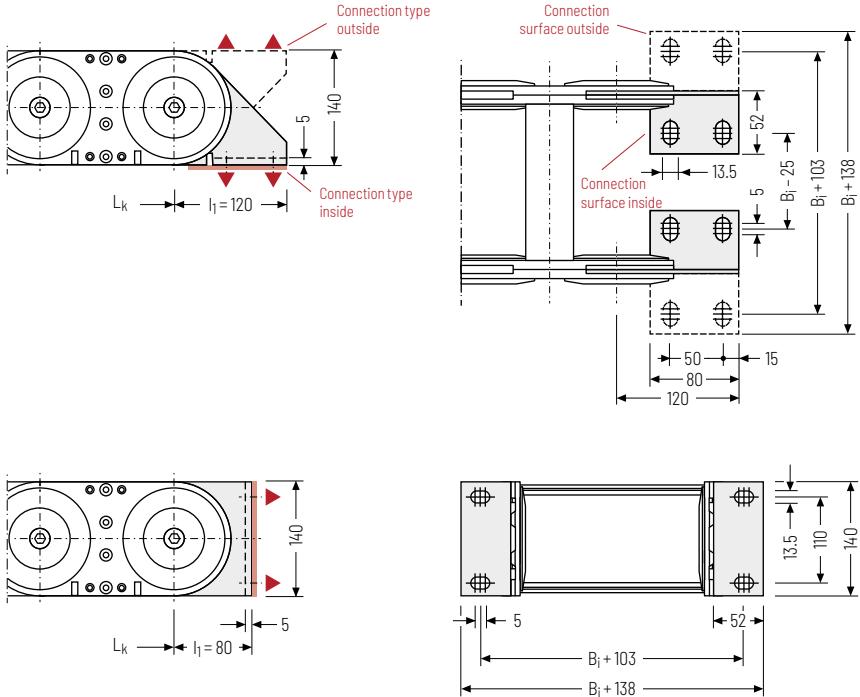

▲ Assembly options

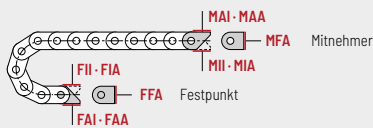

Connection point

F - fixed point
M - driver

Connecting surface

A - connecting surface outside
I - connecting surface inside

Connection type

A - threaded joint outside (standard)
I - threaded joint inside
F - flange connection

Order example



Steel	F	A	I
Steel	M	A	I
End connector	Connection point	Connection type	Connecting surface



We recommend the use of strain reliefs at the driver and fixed point. See from p. 902.

Subject to change without notice.



TRAXLINE®

Accessories

S/SX-Tubes
series

S/SX
series

LS/LSX
series

CLEANVEYOR®

FLATVEYOR®

ROBOTRAX®
System

XLT
series

MT
series

665