

TESTINA PRENSILE

PICK-UP HEAD

TETE DE PREHENSION

GREIFERKOPF

TULIPA

cod. 001.0023 ø 80

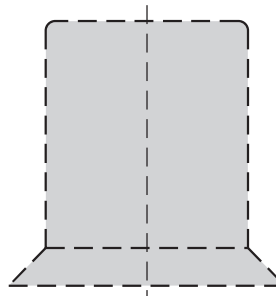
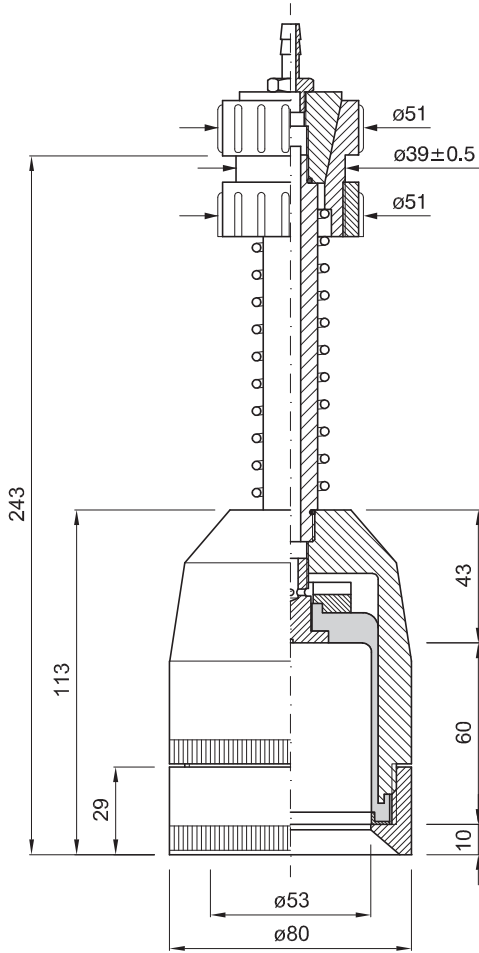

PROFILO INTERNO SCALA 1:2
INTERNAL SECTION SCALE 1:2
PROFIL INTERNE ECHELLE 1:2
INNENPROFIL MASSTAB 1:2
PERFIL INTERIOR ESCALA 1:2

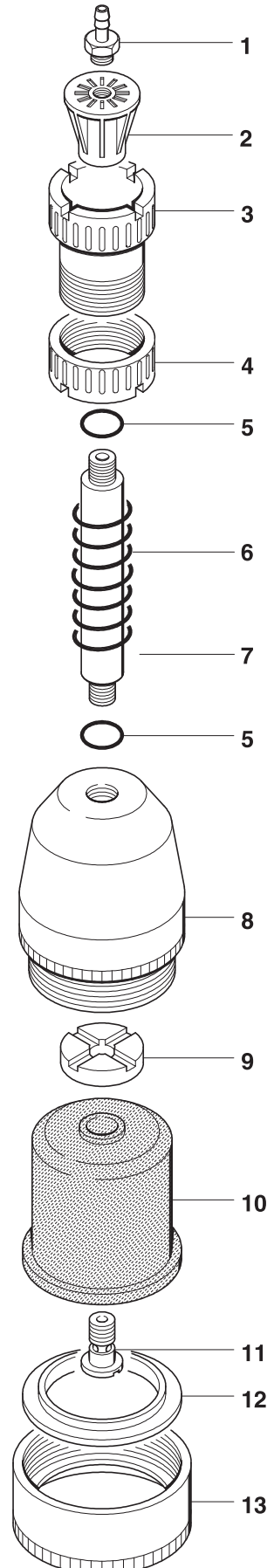

	COD.	MATERIALE	MATERIAL	MATERIEL	WERKSTOFF	MATERIAL
1	024.0001	OTTONE	BRASS	LAITON	MESSING	LATÓN
2	025.0001	PA	PA	PA	PA	PA
3	026.0001	PA	PA	PA	PA	PA
4	026.0011	PA	PA	PA	PA	PA
5	057.0033	GOMMA	RUBBER	CAOUTCHOUC	GUMMI	GOMA
6	029.0001	AISI	STAINLESS STEEL	ACIER INOXYDABLE	ROSTFREIER STAHL	ACERO INOXIDABLE
7	028.0001	AL	AL	AL	AL	AL
8	027.0019	PA	PA	PA	PA	PA
9	032.0203	PA	PA	PA	PA	PA
10	040.0052	GOMMA / TPU	RUBBER / TPU	CAOUTCHOUC TPU	GUMMI / TPU	GOMA / TPU
11	032.0005	OTTONE	BRASS	LAITON	MESSING	LATÓN
12	032.0401	AISI	STAINLESS STEEL	ACIER INOXYDABLE	ROSTFREIER STAHL	ACERO INOXIDABLE
13	026.0047	PA	PA	PA	PA	PA