

TESTINA PRENSILE

PICK-UP HEAD

TETE DE PREHENSION

GREIFERKOPF

TULIPA

cod. 001.0068 ø 50

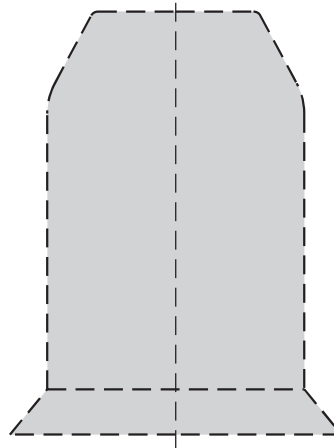
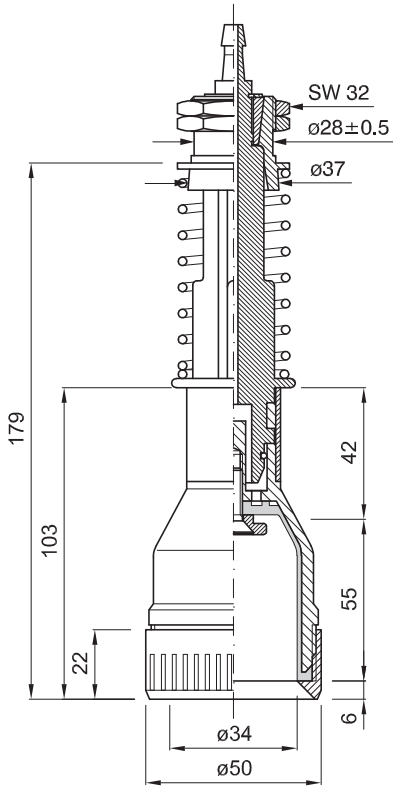

PROFILO INTERNO SCALA 1:1
INTERNAL SECTION SCALE 1:1
PROFIL INTERNE ECHELLE 1:1
INNENPROFIL MASSTAB 1:1
PERFIL INTERIOR ESCALA 1:1

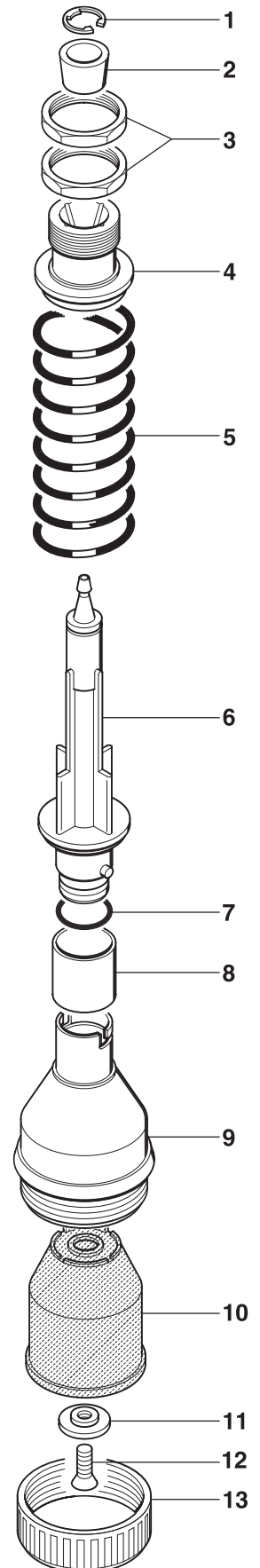

	COD.	MATERIALE	MATERIAL	MATERIEL	WERKSTOFF	MATERIAL
1	032.0014	AISI	STAINLESS STEEL	ACIER INOXYDABLE	ROSTFREIER STAHL	ACERO INOXIDABLE
2	025.0002	PA	PA	PA	PA	PA
3	032.0015	OTTONE	BRASS	LAITON	MESSING	LATÓN
4	026.0002	PA	PA	PA	PA	PA
5	029.0008	AISI	STAINLESS STEEL	ACIER INOXYDABLE	ROSTFREIER STAHL	ACERO INOXIDABLE
6	028.0010	PA	PA	PA	PA	PA
7	057.0017	GOMMA	RUBBER	CAOUTCHOUC	GUMMI	GOMA
8	026.0063	PP	PP	PP	PP	PP
9	027.0054	PA	PA	PA	PA	PA
10	040.0121	GOMMA / TPU	RUBBER / TPU	CAOUTCHOUC TPU	GUMMI / TPU	GOMA / TPU
11	030.0043	PA	PA	PA	PA	PA
12	032.0012	AISI	STAINLESS STEEL	ACIER INOXYDABLE	ROSTFREIER STAHL	ACERO INOXIDABLE
13	026.0106	PA	PA	PA	PA	PA