

TESTINA PRENSILE

PICK-UP HEAD

TÊTE DE PRÉHENSION

GREIFERKOPF

TULIPA

cod. 001.0140 ø 58

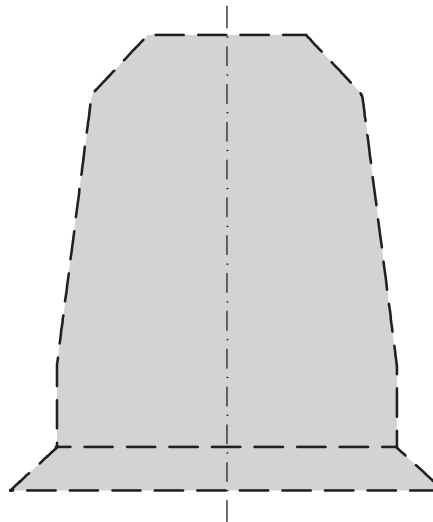
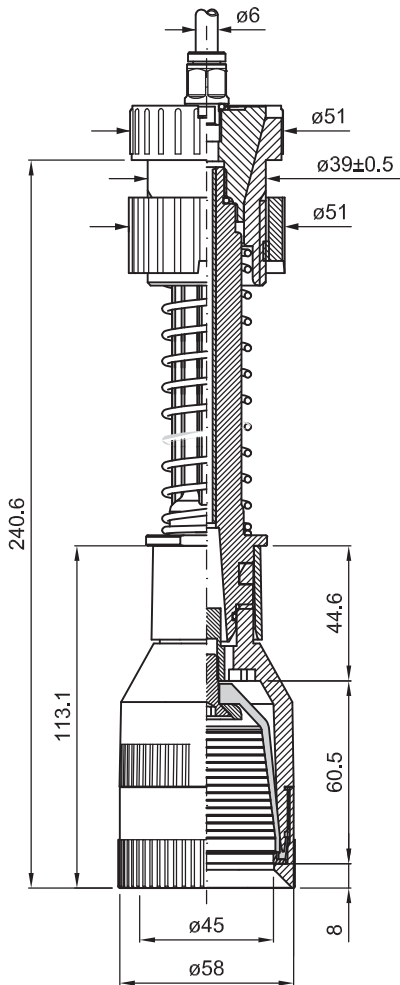

PROFILO INTERNO SCALA 1:1
INTERNAL SECTION SCALE 1:1
PROFIL INTERNE ECHELLE 1:1
INNENPROFIL MASSTAB 1:1
PERFIL INTERIOR ESCALA 1:1

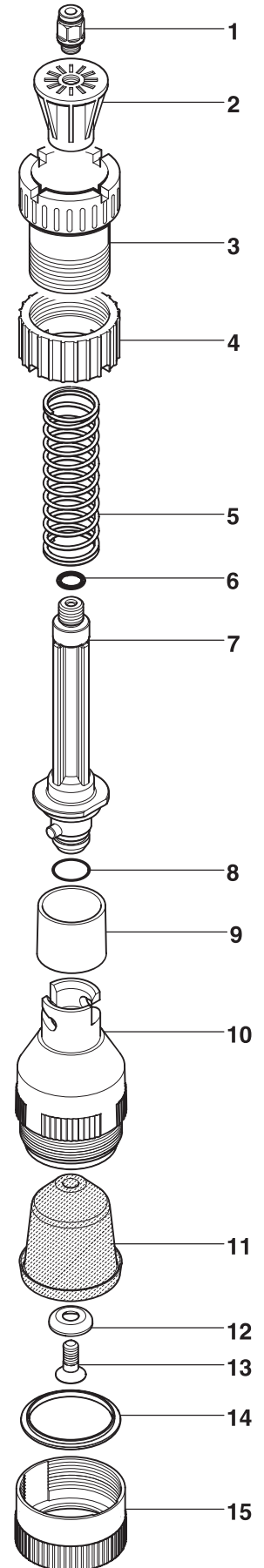

	COD.	MATERIALE	MATERIAL	MATERIEL	WERKSTOFF	MATERIAL
1	024.0007	OTTONE	BRASS	LAITON	MESSING	LATÓN
2	025.00012	PA	PA	PA	PA	PA
3	026.00012	PA	PA	PA	PA	PA
4	026.00112	PA	PA	PA	PA	PA
5	029.0001	AISI	STAINLESS STEEL	ACIER INOXYDABLE	ROSTFREIER STAHL	ACERO INOXIDABLE
6	057.0033	GOMMA	RUBBER	CAOUTCHOUC	GUMMI	GOMA
7	028.0056	PA	PA	PA	PA	PA
8	057.0017	GOMMA	RUBBER	CAOUTCHOUC	GUMMI	GOMA
9	026.0132	PP	PP	PP	PP	PP
10	027.0090	PA	PA	PA	PA	PA
11	040.0155	GOMMA/TPU	RUBBER/TPU	CAOUTCHOUC/TPU	GUMMI/TPU	GOMA/TPU
12	030.0040	PA	PA	PA	PA	PA
13	032.0057	AISI	STAINLESS STEEL	ACIER INOXYDABLE	ROSTFREIER STAHL	ACERO INOXIDABLE
14	032.0419	A.V.P.	A.V.P.	A.V.P.	A.V.P.	A.V.P.
15	026.0138	PA	PA	PA	PA	PA