

External View (Scale 1:50)

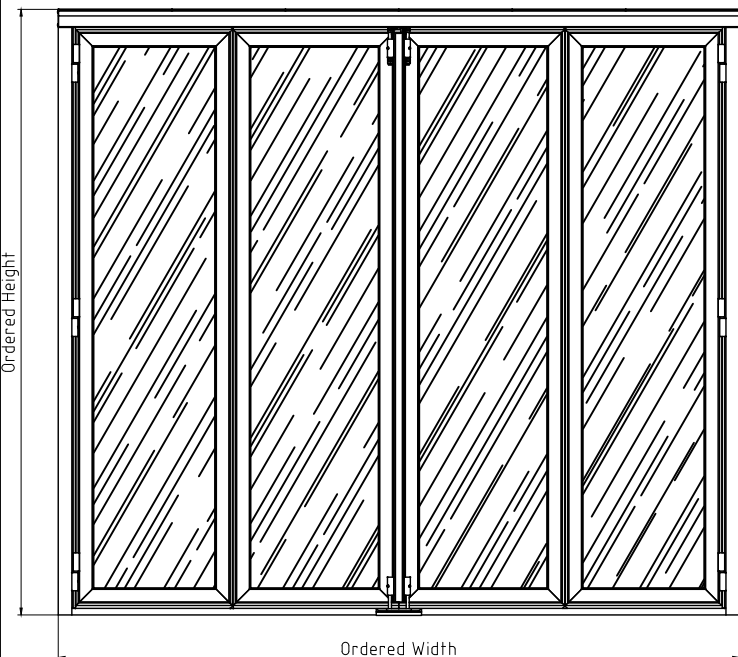

Vertical Cut (Scale 1:50)



Horizontal Cut (Scale 1:50)

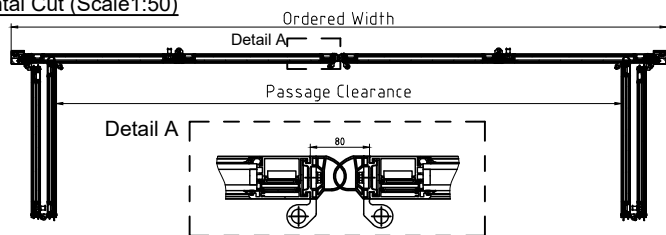

Assembly Situation on the Ledge (Scale 1:10)

a) In front of or behind the reveal IR/BR

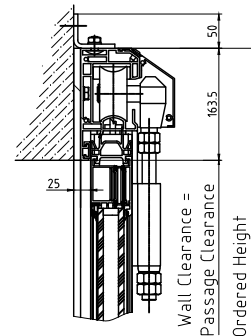

b) In the reveal IR

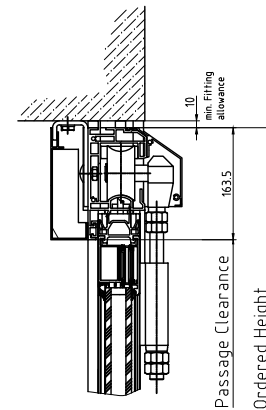

Bottom Details (Scale 1:10)

a) Threshold 55

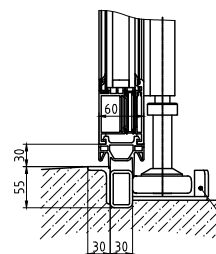

b) Threshold 50

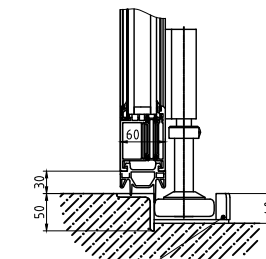

c) Threshold 20

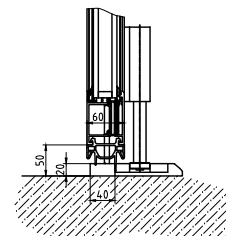

d) Floorguide

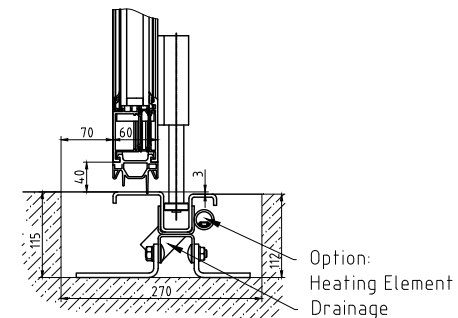

Assembly Situation (Scale 1:10)

a) In front of or behind the reveal IR/BR

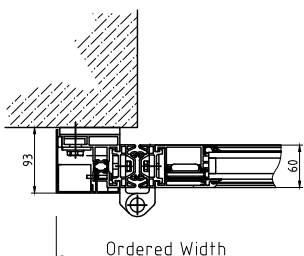

b) In the reveal IR

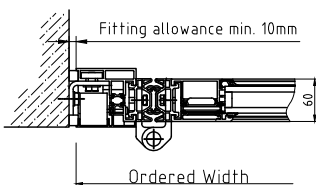

Architectural Sheet
AL603F EEF